

TABLE OF CONTENTS

INTRODUCTION	i
FUNCTIONS	ii
GUIDE TO COMPONENTS	viii
Options	ix
OPERATION PANEL (HARD KEYS)	x
PANEL DISPLAY	xii
Display Panel Layout.....	xiii
FUNCTION LIST BASED ON OPTIONS	xiv

ORIGINALS

ORIGINALS	2
Recommended And Non-recommended Originals	2
SETTING ORIGINALS	4
Setting An Original On The Exposure Glass	5
Setting Originals In The Document Feeder	5
Setting Originals Of Special Sizes.....	7

COPYING

BASIC PROCEDURE	10
BASIC FUNCTIONS	11
Adjusting Image Density.....	11
Selecting The Original Type	12
Selecting Copy Paper.....	13
Having The Machine Choose The Reproduction Ratio (Auto Reduce/ Enlarge).....	14
SORTING INTO SETS (123, 123, 123) (Sort/Rotate Sort)	16
Panel Display For Sort/Rotate Sort	17
Stopping Image Storage And Deleting Stored Images During Copying.....	18
Making Copies In Sort Or Rotate Sort Mode.....	18
COPYING FROM THE BYPASS TRAY	19
When Copying Onto Special Size Copy Paper	21

STORING YOUR COPY SETTINGS IN MEMORY (Program)	22
Storing/Changing The Program	22
Recalling A Program	23
OTHER FUNCTIONS	23
Temporarily Stopping One Job To Copy Something Else (Interrupt) ..	23
Entering Copy Job Settings During The Warm-up Period (Auto Start)	24
Original Beeper	24
REDUCING AND ENLARGING USING PRESET RATIOS	
(Reduce/Enlarge)	25
REDUCING AND ENLARGING IN 1% STEPS (Zoom)	27
STRETCHING AND SQUEEZING THE IMAGE INTO THE COPY AREA	
(Directional Size Magnification)	28
STRETCHING AND SQUEEZING THE IMAGE IN 1% STEPS	
(Directional Magnification(%))	29
MAKING TWO-SIDED COPIES (Duplex)	
(Optional ARDF is Required for 2-Sided → 2-Sided Mode)	30
MAKING ONE-SIDED COPIES FROM VARIOUS ORIGINALS	
(Series Copies) (Optional ARDF is Required for	
2-Sided → 1-Sided Mode)	34
COMBINING ORIGINALS INTO ONE COPY (Combine)	35
COPYING THE IMAGE TWICE ON ONE PAGE (Double Copies)	38
ERASING THE CENTRE AND THE BORDER (Erase Centre/Border)	39
If You Have Pressed The [Centre] Key	40
If You Have Pressed The [Border] Key	41
If You Have Pressed The [Ctr/Bdr] Key	41
EDITING THE COPY IMAGE	42
Reversing Black And White (Positive/Negative)	42
Repeating An Image Over The Entire Copy (Repeat)	42
Merging Images (Overlay)	44
STAPLING (Optional Finisher is Required)	45
Stapling Position And Original Setting	46
COMBINATION CHART	48

WHAT TO DO IF SOMETHING GOES WRONG

IF YOUR COPIER DOES NOT START 50
IF YOU CANNOT MAKE CLEAR COPIES 51
**IF YOU CANNOT MAKE COPIES
AS YOU WANT 53**

CHANGING THE MACHINE'S SETTINGS

ACCESSING THE USER TOOLS (COPY FEATURES) 56
 Returning To Copy Mode 57
USER TOOLS MENU (COPY FEATURES) 58
SETTINGS YOU CAN CHANGE WITH THE USER TOOLS 59
 General Features 1/2 59
 General Features 2/2 60
 Adjust Image 1/2 61
 Adjust Image 2/2 62
 Input/Output 1/2 63
 Input/Output 2/2 64
SERVICE REPRESENTATIVE SETTINGS 64

SPECIFICATIONS

MAINFRAME 66

INDEX

INDEX 70

INTRODUCTION

This manual contains detailed instructions on the operation and maintenance of this machine. To get maximum versatility from this copier all operators should carefully read and follow the instructions in this manual. Please keep this manual in a handy place near the machine.

Please read the “SAFETY INFORMATION” section in the “General Reference” before using this machine. It contains important information related to **USER SAFETY** and **PREVENTING EQUIPMENT PROBLEMS**.

Combine/Series Copies

Combine → Page 35.

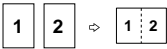
2 originals into 1 copy 

8 originals into 1 copy 

4 originals into 1 copy 

16 originals into 1 copy 

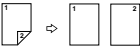

Series Copies → Page 34.

Book → 2 copies 



2-sided → 1-sided 

Editing



Positive/Negative → page 42

 → 

Repeat → page 42.

 → 

Overlay → page 44.

 → 

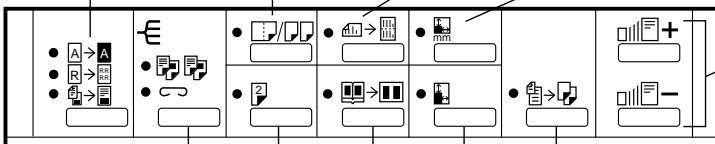

Sort

Sort → page 16.



Rotate Sort → page 16.

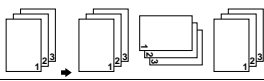

Staple → page 45.



Duplex → page 30.

1-sided → 2-sided

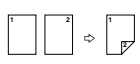

Book → 2-sided

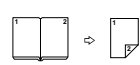

2-sided → 2-sided

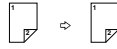

Erase Center/Border → page 39.

Erase Centre



Erase Border

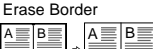

Erase Centre/Border



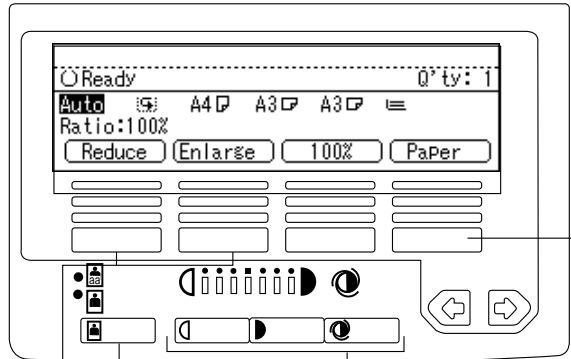
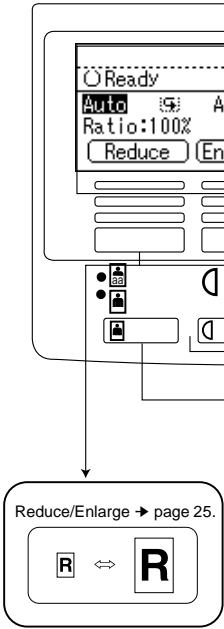
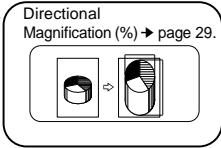
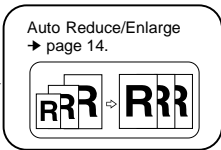
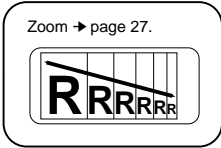
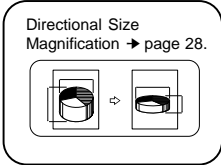
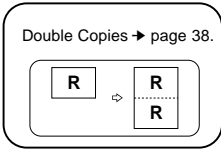

Selecting Copy Paper → page 13.

Selecting Original Type Setting → page 12.

Adjusting Image Density → page 11.

GUIDE TO COMPONENTS

<Front View>

Platen cover (option)

Holds down the original placed on the exposure glass.

Operation panel

⇒ See page x.

Main switch

Switches the machine on/off.

Left side cover

Open to remove misfed paper.

Ventilation hole

Prevents overheating. Do not obstruct the ventilation hole by placing or leaning an object near it. If the machine overheats, a fault might occur.

AC switch

Only use this switch to turn on the machine when it has automatically shut down. (Auto Shut Off, ⇒ "USER TOOLS (SYSTEM SETTINGS) MENU" in the "General Reference")
 · If the machine does not operate after turning on the main switch, check if the AC switch is turned on. If not, turn on it.

Exposure glass

Fit an original face down to the rear left corner.

Internal tray 2 (option)

Copied or printed paper is delivered here face down.

Internal tray 1

Copied or printed paper is delivered here face down.

Front cover

Open to remove misfed paper or supply toner.

Duplex Tray (unit for two-sided copies)

Paper tray

Set paper here. ⇒ See "LOADING PAPER" of "General Reference".

1000-sheet tray unit (option)

External tray

Open to deliver copies, prints and faxes face up when copying from the bypass tray or copying a long size original.

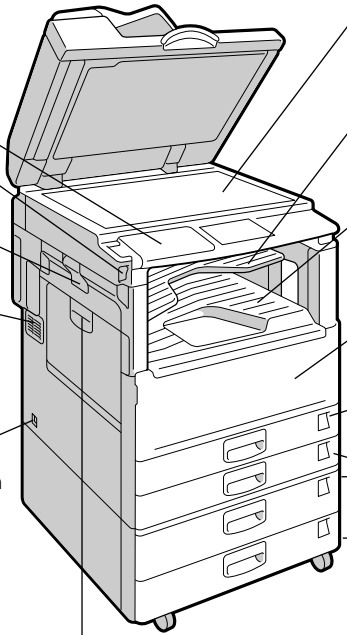

<Right Side View>

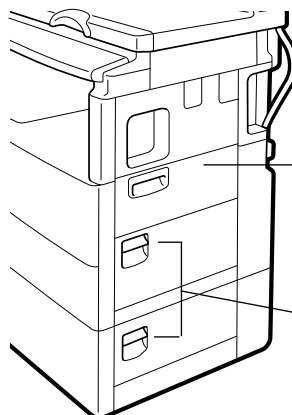

Bypass tray

Use to copy or print onto post cards, OHP transparencies, or other non-standard size paper.

Right Side Cover

Open to remove misfed paper.

Options

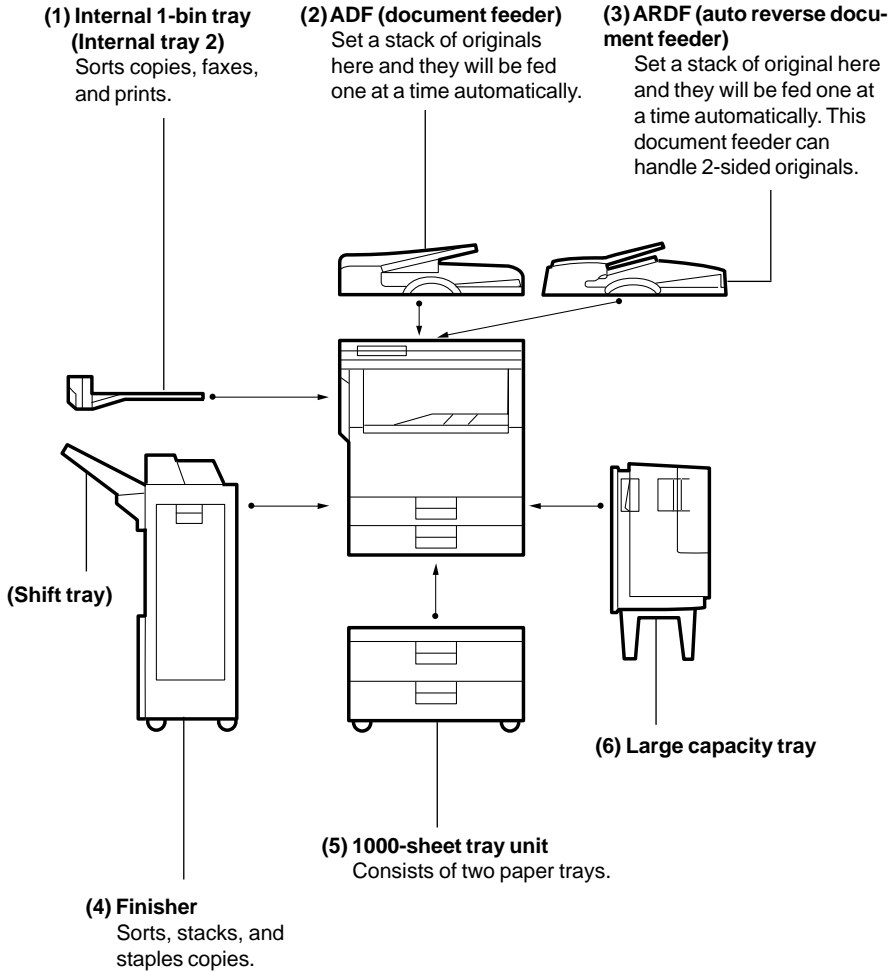

□ Other options: platen cover

OPERATION PANEL (HARD KEYS)

(1) User Tools key

Use to change modes and customize settings. ⇒ See page 56.

(2) Editing key

Selects Positive/Negative, Repeat, or Overlay mode. ⇒ See page 42.

(3) Sorter key

Automatically sorts copies. Staples copies.
⇒ See page 16.
⇒ See page 45.

(4) Combine/Series Copies key

Combine ... Combines 2~16 originals into one copy.
Series Makes two separate one-sided copies from one original(book or 2-sided).
⇒ See pages 34 ~ 35.

(5) Duplex key

Makes two-sided copies.
⇒ See page 30.

(6) Double Copies key

Copies the image twice on one page so that two identical copies are vertically positioned. ⇒ See page 38.

(7) Erase Centre/Border key

Erases the shadow at the center and/or all four sides of the original image.
⇒ See page 39.

(8) Directional Size Magnification key

Makes a copy with the specified height and width. ⇒ See page 28.

◆Copy Operation Panel

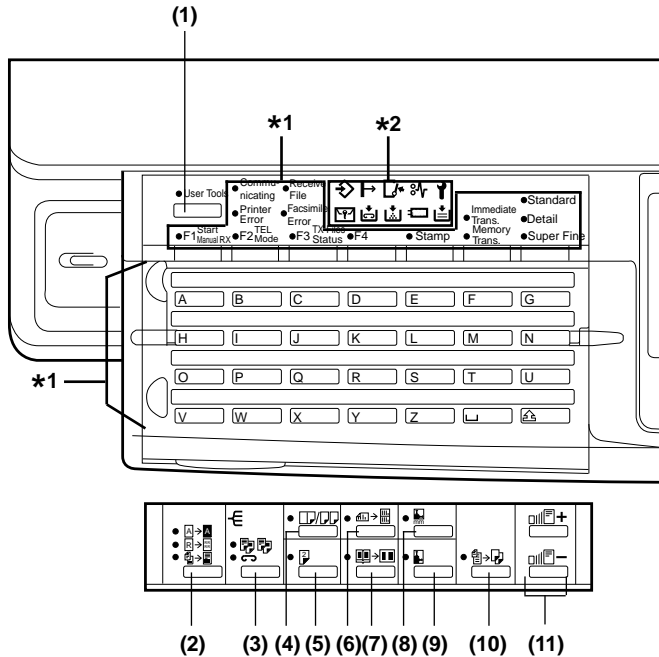
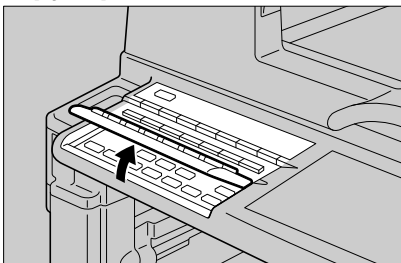

(9) Directional Magnification (%) key

Enlarges or reduces the image at different reproduction ratios horizontally and vertically.
⇒ See page 29.

(10) Auto Reduce/Enlarge key

Enlarges or reduces the image automatically according to the specified paper size.
⇒ See page 14.

(11) + Zoom Up key, - Zoom Down key

Changes the reproduction ratio in 1% steps.
⇒ See page 27.

Flip up the operation panel plate.

- Do not press the plate or put something on it when it is opened.

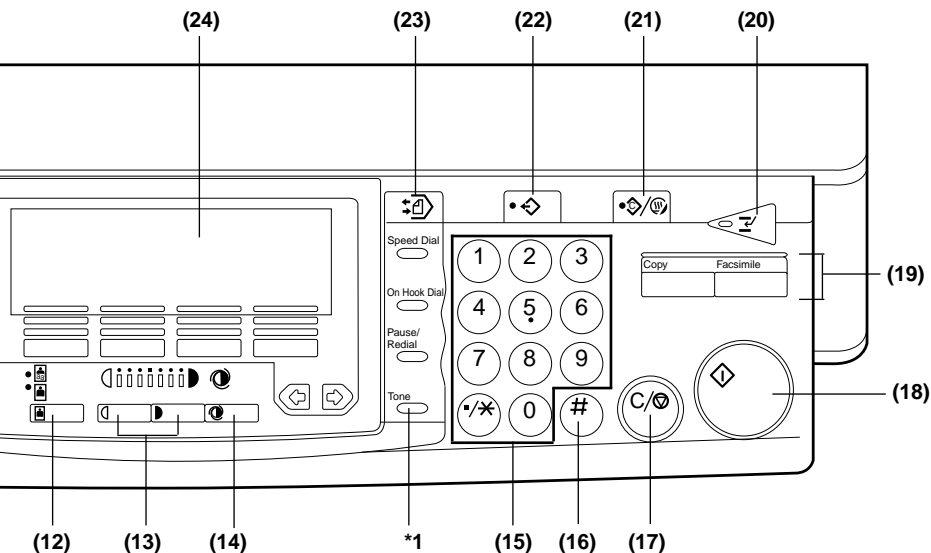
**(12) Original Type key**

Selects type of originals. ⇒ See page 12.

(13) Lighter and Darkey keys

Adjusts the copy image density.
⇒ See page 12.

(14) Auto Image Density key

⇒ See page 12.

(15) Number keys

Use to enter numbers – for example reproduction ratios or number of copies.

(16) Enter key

Sets a value you have entered.

(17) Clear/Stop key

Clear ... Cancels an entered value.
Stop Stops/cancels a copy run.

(18) Start key

Press to start copying.

(19) Function key

Press to switch from Copy mode to another feature. To return to Copy mode press the Copy key.

(20) Interrupt key

Use to interrupt the current job and make copies. ⇒ See page 23.

(21) Clear Modes/Energy Saver key

Clear Modes ... Cancels the settings.
Energy Saver ... Hold down this key for more than a second to enter Energy Save mode.

(22) Program key

Use to program and recall frequently used settings. ⇒ See page 22.

(23) Memory Copy key

Lights when making copies with memory.
When canceling using memory, you can get better image quality copies from originals with gray scale. ⇒ See page 13.

(24) Panel Display ⇒ See page xii.

*1: These keys and indicator are for the optional Fax unit.

*2: See "General Reference".

PANEL DISPLAY

The panel display shows operational status, error messages, and function menus.

- When you select or specify an item on the panel display, it is highlighted like **Auto**. Keys appearing as **OK** cannot be used.
- By default, the machine is in Copy mode when you switch on. This can be changed. ⇒ See “USER TOOLS - SYSTEM SETTINGS” in “General Reference.”

Note: *Do not apply a strong shock or force of about 30 N (about 3 kgf) or more to the panel display. Otherwise, the display might be damaged.*

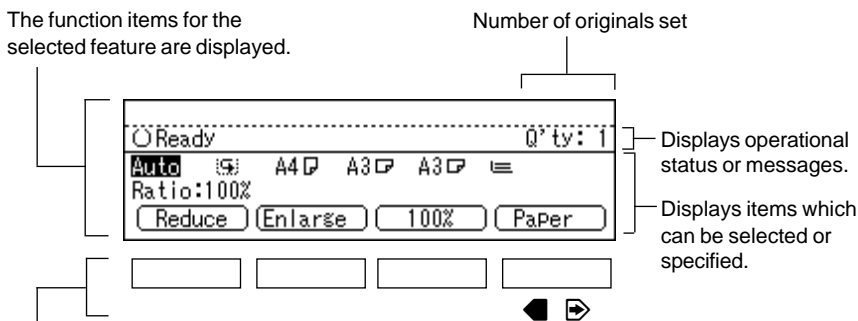

These keys correspond to the items on the display. Press a relevant key to select a function.

◆ In this manual, we use the following conventions

Key name on the panel display: OK

In the manual: **[OK]**

◆ Common keys

[OK] Sets a selected function or entered value and returns to the previous screen.

[Cancel] Cancels a selected function or entered value and returns to the previous screen.

[↑Prev.] When there are too many items fit on the display, use these keys **[↓Next]** to move between pages.

◀ ▶ Press to highlight the selection you wish to select.

[PrevMenu] [Menu]

Press to return to the previous menu.

[Exit] Sets a selected function or entered value and returns to the previous screen.

Display Panel Layout

The basic elements used on the display are shown below. Understanding their meaning help you exploit this machine's features quickly and easily.

<Sample Display for Erasing the Centre/Border>

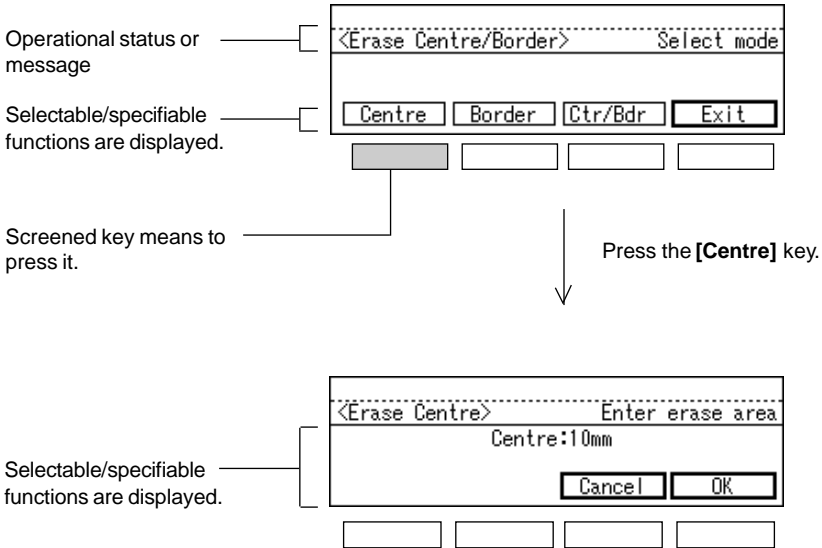

- [OK]** Confirms the settings and returns you to the previous screen.
- [Cancel]** Cancels the settings and returns you to the previous screen.

FUNCTION LIST BASED ON OPTIONS

The function that are available to you depend on your machine configuration and which options you have. See the table below.

○... Available ×... Not available

		Place originals		
			on the exposure glass	in the document feeder *3
Adjusting Image Density		○	○	○
Selecting Original Type		○ *5	○ *5	○ *5
Auto Paper Select		○	○	○
Selecting Copy Paper		○	○	○
Auto Reduce/Enlarge		○	○	○
Sort		○	○	○
Rotate Sort		○ *1	○	○
Copying from the Bypass Tray		○	○	○
Program		○	○	○
Reduce/Enlarge		○	○	○
Zoom		○	○	○
Directional Size Magnification		○	○	○
Directional Magnification (%)		○	○	○
Duplex	1-sided → 2-sided	○	○	○
	Book → 2-sided	○	○	○
	2-sided → 2-sided	*2	○	○
Series Copies	Book → 2-copies	○	○	○
	2-sided → 2-copies	*2	○	○
Combine	2 originals → 1 copy (2 in 1)	○	○	○
	4 originals → 1 copy (4 in 1)	○	○	○
	8 originals → 1 copy (8 in 1)	○	○	○
	16 originals → 1 copy (16 in 1)	○	○	○
Double copies		○	○	○
Erase Center/Border		○	○	○
Editing		○	○	○
Optional Stapling		*4	*4	*4

*1 Requires two paper trays identical in size but with different orientations.

*2 Requires the optional auto reverse document feeder.

*3 There are two kinds of document feeder. ⇒ See page ix.

*4 Requires the optional finisher.

*5 25% ~ 49% can be selected only when the Text and Memory Copy modes are selected. ⇒ See pages 12~13.







ORIGINALS

ORIGINALS	2
Recommended And Non-recommended Originals	2
SETTING ORIGINALS	4
Setting An Original On The Exposure Glass	4
Setting Originals In The Document Feeder	5
Setting Originals Of Special Sizes	7







Recommended And Non-recommended Originals

Sizes and weights of recommended originals

Metric version

	Size	Weight
on the exposure glass	Up to A3 (297 × 420 mm) Maximum : 297 × 432 mm	—
in the document feeder	A3  - A5  Maximum 297 × 1260 mm	52 - 105 g/m ² (14 - 28 lb)
in the auto reverse document feeder	1-sided originals: A3  -A5  Maximum: 297 x 1260 mm 2-sided originals: A3  -B5 	52 - 105 g/m ² (14 - 28 lb)

Inch version

	Size	Weight
on the exposure glass	Up to 11" × 17" (279 x 432 mm) Maximum : 11.7" × 17"	
in the document feeder	11" × 17"  - 5½" × 8½"  Maximum : 11.7" × 49.6"	52 - 105 g/m ² (14 - 28 lb)
in the auto reverse document feeder	1-sided originals: 11" × 17"  -5½" × 8½"  Maximum: 11.7" x 49.6" 2-sided originals: 11" × 17"  -8½" × 11" 	52 - 105 g/m ² (14 - 28 lb)

- You can set up to about 30 originals (80 g/m², 20 lb) in the document feeder.
- If you use sizes other than those above, enter the vertical and horizontal sizes.
⇒ See page 7.

Non-recommended originals for the document feeder

- Setting the following originals in the document feeder may cause a paper misfeeds or damage to the originals. Set these originals on the exposure glass.
 - Originals of sizes other than those shown above
 - Originals with staples or clips
 - Perforated or torn originals
 - Curled, folded, or creased originals
 - Pasted originals

- Originals with any kind of coating, such as thermosensitive paper, art paper, aluminum foil, carbon paper, or conductive paper
- Originals with indexes, tags, or other projecting parts
- Sticky originals such as translucent paper
- Thin and soft originals
- Originals of inappropriate weight (⇒ See the table on the previous page.)
- Originals in bound form such as books
- Transparent originals such as OHP transparencies or translucent paper
- Damp originals
- Wavy originals
- Originals that are not made from paper
- Originals written in pencil on both sides, or two-sided carbon originals
- Originals with globs of ink from a ball-point pen

Sizes difficult to detect

- It is difficult for the machine to detect the sizes of the following originals. Auto Paper Select might not select paper of the correct size for these originals. Select the paper size manually for these originals.
 - Originals with indexes, tags, or other projecting parts
 - Transparent originals such as OHP transparencies or translucent paper
 - Dark originals with many characters and drawings
 - Originals which partially contain solid printing
 - Originals which have solid printing at their edges
 - Originals other than those (with ○) in the tables below.

Sizes detectable by auto paper select

Metric version

Size Place of original	A3	B4	A4	B5	A5	11"×17"	8½"×14"	8½"×11"	5½"×8½"	8"×13"
Exposure glass	○	○	○	○	×	×	×	×	×	○
Document feeder	○	○	○	○	○	×	×	×	×	○

Inch version

Size Place of original	A3	B4	A4	B5	A5	11"×17"	8½"×14"	8½"×11"	5½"×8½"
Exposure glass	×	×	×	×	×	○	○	○	×
Document feeder	×	×	×	×	×	○	○	○	○

Size Place of original	10"×14"	8½"×13"	8"×10"
Exposure glass	○	○	○
Document feeder	○	×	○

SETTING ORIGINALS

Sizes and scanning area/missing image area

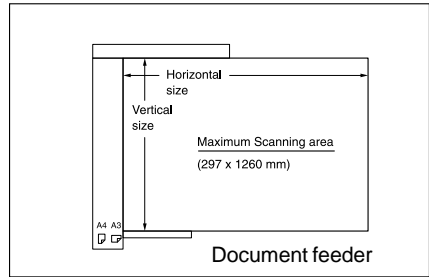
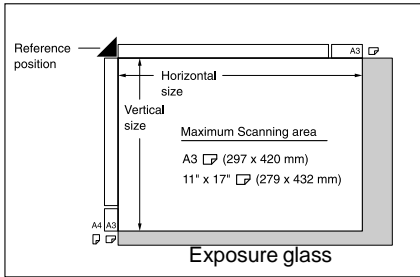

- ❑ When you correctly set an original in the document feeder or on the exposure glass, an area of about 3mm width surrounding the original might not be copied.

SETTING ORIGINALS

Set the original on the exposure glass or in the document feeder. This should be done correctly according to the type of originals and copying method.

- ❑ Align the original to the rear left corner. The copying results might vary depending on the direction of the set original. See the description of each function.

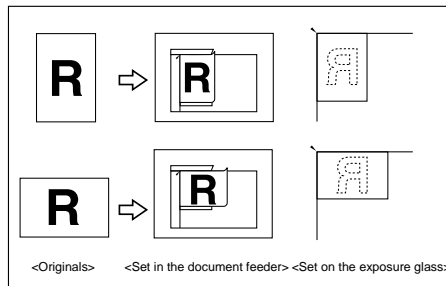

- ❑ Set the original after correction fluid and ink has completely dried. Not taking this precaution could mark the exposure glass causing marks to be copied.

Setting An Original On The Exposure Glass

1 Lift the platen cover/document feeder. Set the original *face down* on the exposure glass. The original should be aligned to the rear left corner.

- ❑ Be sure to open the platen cover /document feeder by more than 30°. Otherwise the original size might not be detected correctly.

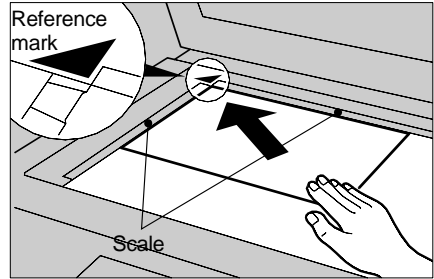

2 Lower the platen cover/document feeder.

Setting Originals In The Document Feeder

- ❑ You cannot set originals of different sizes at the same time. If you want to use such originals, set one original at a time (SADF mode).
- ❑ If you copy thin originals, set one original at a time in the document feeder or on the exposure glass to avoid damage to the originals due to a multi-sheet feed (which means that multiple sheets are fed together at the same time).
- ❑ If you set two or more originals in the document feeder and copies exit to the external tray, page order of copies becomes reverse.

Setting a stack of originals in the document feeder

1 Adjust the document guide to the original size. Set the aligned originals *face up* into the document feeder.

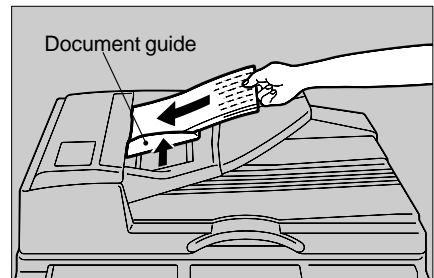

Setting one original at a time in the document feeder

- 1** Set one original *face up* into the document feeder. Press the **Start** key.

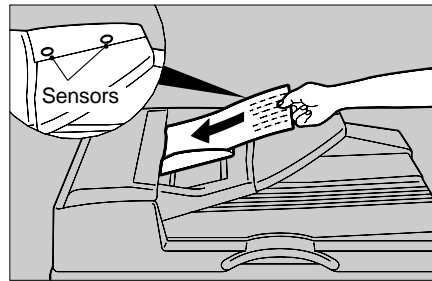

- 2** When the message appears (see the illustration), set the next original. The second and subsequent originals can be fed automatically without pressing the **Start** key.

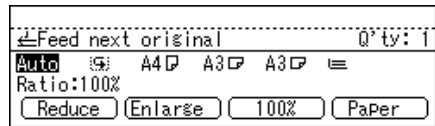

- Do not block the document feeder sensors. Also, be sure to set originals correctly. Otherwise, the original size might not be detected correctly.
- You can adjust the time the machine waits before being ready for the next original. → See page 63.

Setting a stack of originals in the auto reverse document feeder

- 1** Adjust the document guide to the originals size. Set the aligned originals *face up* into the auto reverse document feeder.

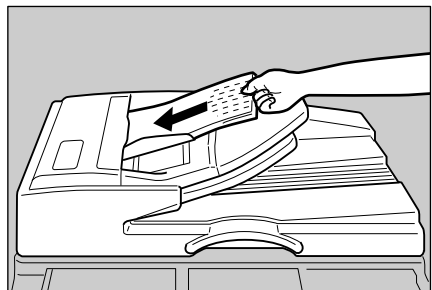

Setting one original at a time in the auto reverse document feeder

- 1 Adjust the document guide to the original size. Set one original into the auto reverse document feeder. Press the **Start** key.

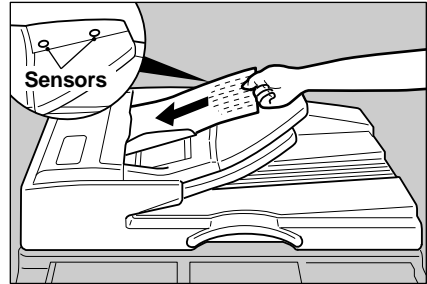

- 2 When the message appears (see the illustration on the previous page), set the next original. The second and subsequent originals can be fed automatically without pressing the **Start** key.
 - You can adjust the time the machine waits before being ready for the next original. →See page 63.
 - Do not block the document feeder sensors. Also, be sure to set originals correctly. Otherwise, the original size might not be detected correctly.

Setting Originals Of Special Sizes

- You can set originals of the following sizes.
Metric version: length 128 to 1260 mm, width: 105 to 297 mm
Inch version: length 5.0" to 49.6", width: 4.1" to 11.7"
- You cannot use the Editing functions with the special size originals.
- You cannot make multi-copies of special size originals.
- Special original size setting will be cleared by Copy Reset or by pressing the **Clear Modes/Energy Saver** key.

- 1 Set one original in the document feeder.
- 2 Select paper or bypass tray (≡) with **[Paper]** or the ◀ ▶ keys.
- 3 Press the ● key. The non-standard paper menu will appear.
 - If you select the bypass tray in step 2, the display appears.

When you have selected the bypass tray in step 2

- ❶ Enter the horizontal size of the copy paper with the **Number** keys and press the **●** key.
- ❷ Enter the vertical size of the copy paper with the **Number** keys press the **[Org. Size]** key.
- ☐ Go to step 4.

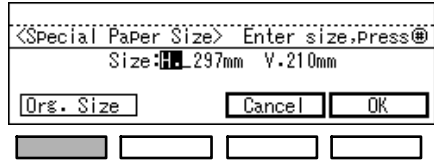

- ❸ Enter the horizontal size of the original with the **Number** keys and press the **●** key.

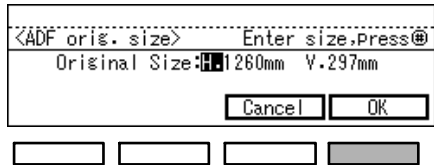

- ❹ Enter the vertical size of the original with the **Number** keys and press the **[OK]** key.

- ☐ \square (special original size) appears on the display.

- ❺ Press the **Start** key.

Canceling the special original size setting

Special original size setting will be cleared by Auto Reset, or by pressing the **Clear Modes/Energy Saver** key. However, if you press the **Clear Modes/Energy Saver** key, all other settings are also cleared. If you want to cancel only the special original size setting, do the following procedure.

- ❶ Make sure that originals are in the document feeder.
- ❷ Select any paper size (except bypass tray) with the **[Paper]** or **◀▶** keys.
- ❸ Press the **●** key.
- ❹ Press the **[Cancel]** key.

COPYING

BASIC PROCEDURE	10
BASIC FUNCTIONS	11
Adjusting Image Density	11
Selecting The Original Type	12
Selecting Copy Paper	13
Having The Machine Choose The Reproduction Ratio (Auto Reduce/Enlarge)	14
SORTING INTO SETS (123, 123, 123) (Sort/Rotate Sort)	16
Panel Display For Sort/Rotate Sort	17
Stopping Image Storage And Deleting Stored Images During Copying	18
Making Copies In Sort Or Rotate Sort Mode	18
COPYING FROM THE BYPASS TRAY	19
When Copying Onto Special Size Copy Paper	21
STORING YOUR COPY SETTINGS IN MEMORY (Program)	22
Storing/Changing The Program.....	22
Recalling A Program	23
OTHER FUNCTIONS	23
Temporarily Stopping One Job To Copy Something Else (Interrupt)	23
Entering Copy Job Settings During The Warm-up Period (Auto Start)	24
Original Beeper	24
REDUCING AND ENLARGING USING PRESET RATIOS (Reduce/Enlarge)	25
REDUCING AND ENLARGING IN 1% STEPS (Zoom)	27
STRETCHING AND SQUEEZING THE IMAGE INTO THE COPY AREA (Directional Size Magnification)	28
STRETCHING AND SQUEEZING THE IMAGE IN 1% STEPS (Directional Magnification(%))	29
MAKING TWO-SIDED COPIES (Duplex) (Optional ARDF is Required for 2-Sided → 2-Sided Mode)	30
MAKING ONE-SIDED COPIES FROM VARIOUS ORIGINALS (Series Copies) (Optional ARDF is Required for 2-Sided → 1-Sided Mode)	34
COMBINING ORIGINALS INTO ONE COPY (Combine)	35
COPYING THE IMAGE TWICE ON ONE PAGE (Double Copies)	38
ERASING THE CENTRE AND THE BORDER (Erase Centre/Border)	39
If You Have Pressed The (Centre) Key	40
If You Have Pressed The (Border) Key	41
If You Have Pressed The (Ctr/Bdr) Key	41
EDITING THE COPY IMAGE	42
Reversing Black And White (Positive/Negative)	42
Repeating An Image Over The Entire Copy (Repeat)	42
Merging Images (Overlay).....	44
STAPLING (Optional Finisher is Required)	45
Stapling Position And Original Setting	46
COMBINATION CHART	48

BASIC PROCEDURE

1 Make sure that the machine is in Copy mode.

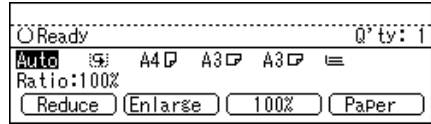

Press the **Copy** key if the Ready screen is not displayed. ⇒ See page xi.

If you set two or more originals in the document feeder and copies exit to the external tray, page order of copies becomes reverse.

When in User Code mode

1 Enter the user code (less than four digits) with the **Number** keys and then press the **Start** key. The machine gets ready for copying. ⇒ See “STARTING THE MACHINE” in “General Reference.”

2 Make sure that there are not previous settings remaining. Press the **Clear Modes/Energy Saver** key.

3 Set the original.
⇒ See “SETTING ORIGINALS” on page 4.

4 Choose any settings you require.

5 Enter the number of copies with the **Number** keys.

If you enter a wrong value, press the **Clear/Stop** key and re-enter a correct value.

6 Press the **Start** key. The machine starts copying.

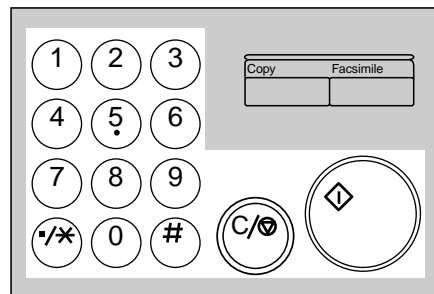

To stop the machine, press the **Clear/Stop** key.

To return the machine to the initial condition after copying, press the **Clear Modes/Energy Saver** key.

You can change the default settings of basic functions.
See “USER TOOLS - SYSTEM SETTINGS” in “General Reference.”

- ❑ If you do not operate the machine for a certain period after copying, the machine returns to the initial screen. This is called “Copy Reset.” You can change the Copy Reset period. ⇒ See “USERS TOOLS-SYSTEM SETTING” in “General Reference.”
- ❑ You can specify whether or not Energy Save mode at the same time as System Auto Reset comes effect. ⇒ See “USERS TOOLS-SYSTEM SETTING” in “General Reference.”
- ❑ Copy Reset does not work in the following cases:
 - When an original is left in the machine.
 - When an original image is stored in memory.
 - When in the User Tools mode.
 - When the paper tray with no paper is selected.

BASIC FUNCTIONS

The following basic functions are explained in this section.

Adjusting Image Density

Auto and Manual Image Density

Selecting Original Type

Text/Photo and Photo

Selecting Copy Paper

Auto Paper Select and Manual Paper Select

One-to-one Copying and Auto Reduce/Enlarge

Sort This function sorts copies.

Rotate Sort

This function rotates every other copy set by 90° and delivers all copy sets to the paper trays if you set the paper trays for alternate sheets (and) of the same size.

- ❑ You can change the settings selected after the main switch is turned on, after the Energy Save is reset, or after the Copy Reset. ⇒ See page 57.

Adjusting Image Density

There are three ways to adjust the image density:

◆Auto Image Density

The dark background on newspaper or recycled paper is not copied.

BASIC FUNCTIONS

◆Manual Image Density

You can adjust the image density to get a darker or lighter image.

◆Combination of Auto and Manual Image Density

Use this combination when the originals have dirty background and you want to adjust the density without affecting the background.

Auto Image Density

1 Be sure that the **Auto Image Density** indicator is lit.

- If it is not lit, press the **Auto Image Density** key.
- Choose any other settings and make your copies.

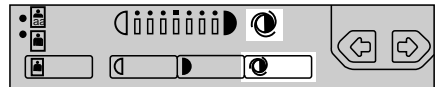

Adjusting image density manually (Manual Image Density)

1 Press the **Auto Image Density** key.

- Auto Image Density** indicator turns off.

2 Press the **Lighter** or **Darker** key to adjust the image density.

- Choose any other other settings and make your copies.

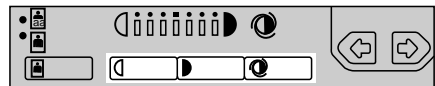

Adjusting the image density with auto and manual image density

1 Make sure that the **Auto Image Density** indicator is lit. Press the **Lighter** or **Darker** key to adjust the density.

- Choose any other settings and make your copies.

Selecting The Original Type

You can select two original types.

◆Text/Photo



Use this mode when making copies with originals containing photographs or containing drawings with letters. (e.g. a map, a magazine)

◆Photo

Select this mode when copying photographs or drawings. This mode is especially suitable for large photographs or drawings.

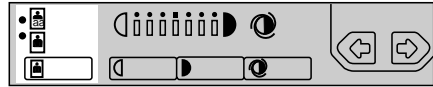
- 1 Press the **Original Type** key and select the type of original.





- Pressing the **Original Type** key to step through the available types as follows:
 - No indicator lights: Text
 - Upper indicator lights: Text/Photo
 - Lower indicator lights: Photo
- When using the Text/Photo or Photo mode, the range of reproduction ratio you can select is 50% ~ 400%. If you want to use 25% ~ 49%, please contact your service representative.
- If you want to use the originals with gray scale, you can get better image quality copies by canceling the Memory Copy mode. To cancel the Memory Copy mode, press the **Memory Copy** key to turn off the indicator on it.
When you cancel the Memory Copy mode, there are some limitations as follows:
 - If you set an original in the document feeder, the machine cannot make multiple copies of the original. If you want to make multiple copies, place originals on the exposure glass.
 - The copying speed decreases from 25 copies/minute to 20 copies/minute (for A4 , 8½" x 11" ).
 - Image Rotation, Rotate Sort, Combine, continuous copying in the Duplex mode, and top to bottom binding in the Duplex mode are impossible.
 - The range of reproduction ratio you can select is 50% ~ 400%.
- Choose any other settings and make your copies.

Selecting Copy Paper

There are two ways to select paper:

◆Auto Paper Select

The machine selects a suitable size of paper automatically based on the original size and the reproduction ratio.

- When the original is set at a different direction from the copy paper in the paper tray, the machine automatically rotates the original image by 90° to match the copy paper direction and make copies. This applies to the following paper sizes:
 - Metric version : A4 , B5 
 - Inch version : 8½" x 11" 

BASIC FUNCTIONS



- ❑ If you use A4, B5 or 8½" x 11" originals and there are two paper trays with paper identical in size and different in direction with originals, the machine copies onto the copy paper (sideways ) which allows copying at the fastest speed (except for sorting).
- ❑ When copying from originals with gray scale, press the **Memory Copy** key to cancel using the memory. Select copy paper identical in direction to the original.



◆Manual Paper Select

Select the paper tray or bypass tray. ⇒ See “COPYING FROM THE BY-PASS TRAY” on page 19.

- ❑ Regarding paper size that can be used for this machine, ⇒ See “COPY PAPER” in the “General Reference”.
- ❑ Regarding original sizes that can be detected, see page 3.
- ❑ For some originals, the matching size of copy paper cannot be selected. ⇒ See page 3.

Selecting copy paper

1 Select copy paper with [**Paper**] or   keys.

- ❑ If you select the bypass tray ( or ) ⇒ See “COPYING FROM THE BYPASS TRAY” on page 19.
- ❑ Choose any other settings and make your copies.

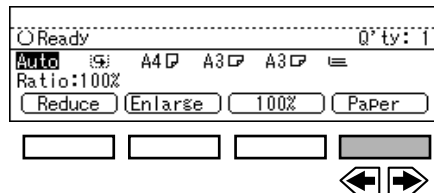

Having The Machine Choose The Reproduction Ratio (Auto Reduce/Enlarge)

The machine can choose an appropriate reproduction ratio based on the paper and original sizes you select.

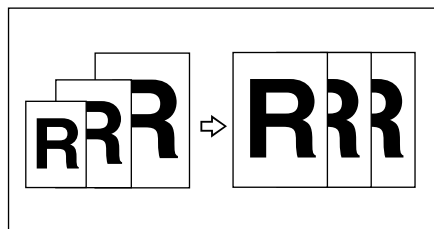

- With this function, it is not necessary for you to select the reproduction ratio.
- This function is useful for copying from originals of different sizes to paper of the same size.
- The following reproduction ratios are selectable:

	Text mode in Memory Copy mode	Except the left case
Setting originals on the exposure glass	25~400%	50~400%
Setting originals in the document feeder	25~190%	50~190%

- Copying from the bypass tray is impossible with this feature.
- When the original is set at a different direction from the selected copy paper, the machine cannot rotate the image by 90°. Be sure to set the original in the same direction as the copy paper.
- The following originals can be detected correctly;
 - Metric version: A3 , B4 , A4 , B5 ,
A5 (for document feeder only), 8" x 13"
 - Inch version: 11" x 17" , 8½" x 14" , 8½" x 11" , 10" x 14" ,
8" x 10" , 5½" x 8½" (for document feeder only)
8½" x 13" (for document feeder only)
- For some originals, the matching size of copy paper cannot be selected. ⇒ See page 3.

1 Press the **Auto Reduce/Enlarge** key.



2 Select copy paper with **[Paper]** or **◀▶** keys.

- Choose any other settings and make your copy.

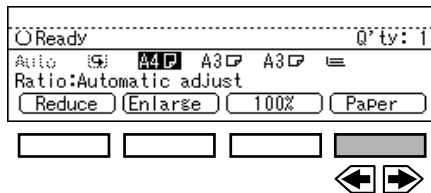

SORTING INTO SETS (123, 123, 123) (Sort/Rotate Sort)

The machine can make copies and collate them into sets for meetings or other purposes. Each set will be ordered by page number. In Rotate Sort mode, every other copy set is rotated by 90° and delivered to the tray so that each set can be easily separated. Sort mode delivers copy sets without rotation.

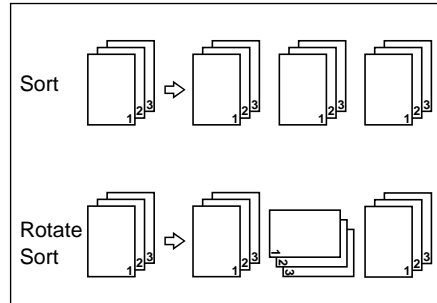

- If your machine is not equipped with the optional finisher, the Rotate Sort mode is selected by default when you try to use the sorting function. You can change this setting. ⇒ See page 64.
- If your machine is equipped with the optional finisher, the Sort mode is selected by default when you try to use the sorting function. You can change this setting. ⇒ See page 64.
- If your machine is equipped with the optional finisher, you can specify the output tray in the Sort mode. ⇒ See page 64.
- You can make up to 99 copy sets at a time.
- The output tray can hold the following number of sheets:

Output tray	Number of sheets	
Internal tray 1	500	
Internal tray 2	125	
External tray	100	
Finisher	face up	250 (A3, 11" × 17" or smaller)
	face down	1,000 (A4, 8½" × 11" ~ A5□) (5½" × 8½" does not exit face up.) 500 (B4, 8½" × 14" or larger)



If the number of sheets exceeds the capacity, remove the sheets.

- To avoid problems caused by curled copies, try turning over the paper stack in the tray. If there is no improvement, change to copy paper with less curl.
- Sort/Rotate Sort mode does not support different-size or different-direction originals.
- After starting copying, the only setting you can change is image density and original type. These changes does not apply to images that have been stored in the memory.

SORTING INTO SETS (123, 123, 123) (Sort/Rotate Sort)

- ❑ You cannot copy from the bypass tray with this feature.
- ❑ Originals of the following sizes can be used:

Paper Size	Sort	Rotate Sort
A4, B5, 8½" x 11"	○	○
B4, 8½" x 14", A3, 11" x 17"	○	×

· Two paper trays are required for the Rotate Sort. Put copy paper  and  of the same size on the paper trays.

- ❑ As a default, two paper trays identical in size but different in direction must be available in Rotate Sort mode. You can change this setting. ⇒ See page 64.
- ❑ The copying speed might be slower than that for normal copying. Also, it depends on the type of original and the original type setting (Photo, Text/Photo, or Text).
- ❑ The number of originals that can be stored in memory depends on their type. The memory capacity for originals with photographs is smaller than that for originals without.

Panel Display For Sort/Rotate Sort

- ❑ You can set the panel display to indicate the number of originals fed through the document feeder. ⇒ See page 63.

Example) Making two copy sets of each of three originals

Before copying: Q'ty: 2 ... Number of copy set you enter

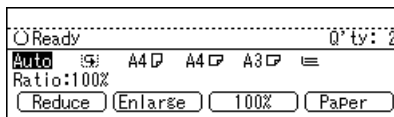

During copying:

Orig. 1 → 2 → 3 ... Number of scanned originals

Copy 1 → 1 → 1 2 → 2 → 2 ... Number of copies

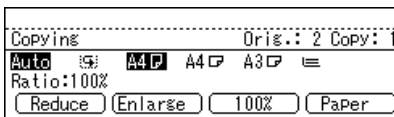

Stopping Image Storage And Deleting Stored Images During Copying

◆ Stopping storing while scanning originals

- Press the **Clear/Stop** key.

◆ Deleting stored images after copying has been interrupted

- Press the **Clear Modes/Energy Saver** key. The stored images will be cleared.

◆ Re-starting scanning originals

- Press the **Start** key.

Making Copies In Sort Or Rotate Sort Mode

- 1** Press the **Sorter** key to light the **Sort** (upper) indicator.



- 2** Enter the number of copies and choose any settings you require.

When setting originals one at a time on the exposure glass or in the document feeder

- 1** Set the original and then press the **Start** key. The machine starts scanning.
 - Start with the first page to be copied.
 - When making one-sided copies, the first set of copies comes out first.
- 2** Set the next original and then press the **Start** key.
 - Set the originals in the same direction as step **1**.
 - When the remaining memory space reaches 0 %, the machine stops memorizing. Press the **[Output]** key to finish copy jobs which are already in memory. Continue copying by following the instructions on the panel display. If you want to delete the stored images, press the **[Clear]** key.
- 3** When the machine finishes scanning all the originals, press the **●** key.
- 4** Press the **Start** key. The copies will be delivered.

When setting a stack of originals in the document feeder

- ❶ Set the originals and then press the **Start** key.
When the machine finishes scanning, copies are automatically delivered.
- ❑ The first page must be on top.
- ❑ When the machine makes one-sided copies, the first set of copies comes out first.
- ❑ When the remaining memory space reaches 0%:
 - The machine stops scanning originals.
 - Press the **[Output]** key to finish copy jobs which are already into memory. Remove copies from the tray and continue copying following the instructions on the panel display.
 - If you press the **[Clear]** key, the copy jobs which have been stored will be cleared and copying stops.

COPYING FROM THE BYPASS TRAY

Use the bypass tray to copy onto OHP transparencies, adhesive labels, translucent paper, post cards, and copy paper that cannot be set in the paper tray.

- ❑ See “Copy Paper” in “General Reference” for information about the size and direction of copy paper to be set on the bypass tray.
- ❑ Be sure to specify the size of copy paper other than following because the machine cannot automatically detect the size. You can set copy paper with a width of 90 to 305 mm (3.5" to 12") and length of 148 to 432 mm (5.8" to 17.0").
- ❑ When you make multi-copies using sideways (☐) paper from the bypass tray, reverse sides of copies might be stained. It is recommended to set paper in the bypass tray lengthwise (☐).
- ❑ Regarding paper sizes that can be used, see “COPY PAPER” in the “General Reference”.
- ❑ Open the external tray before copying because the external tray is selected to receive copies by default. You can change this setting.
⇒ See page “USER TOOLS - SYSTEM SETTINGS” in the “General Reference”.
- ❑ When you make copies on OHP transparencies or thick paper, it is recommended to feed them from the bypass tray and to exit them to the external tray. Otherwise, misfeeds might occur.

COPYING FROM THE BYPASS TRAY

1 Open the bypass tray.

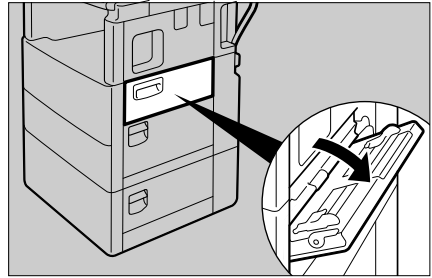

2 Select the bypass tray (≡ or ✖) with the **[Paper]** or the **◀ ▶** keys.

3 Lift the paper hold lever.

- ❑ Swing out the extender if setting copy paper larger than A4 \square , $8\frac{1}{2}'' \times 11'' \square$.

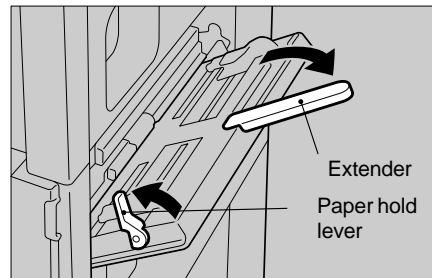

4 Slide the paper guides to match the paper width. Insert the copy paper until it stops.

- ❑ If the guides are not flush with the copy paper, a skew image or paper jam might occur.
- ❑ The image will be copied on the side of paper that you place face up.
- ❑ Fan OHP transparencies or translucent paper to get air between them to avoid a multi-sheet feed (multiple sheets fed together at the same time).

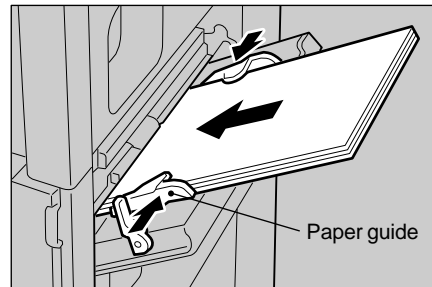

5 Lower the paper holder lever. Otherwise, paper misfeed might occur.

- ❑ If you have set copy paper larger than A4 \square , $8\frac{1}{2}'' \times 11'' \square$, support the trailing edge of copy paper with your hand when lowering the paper holder.

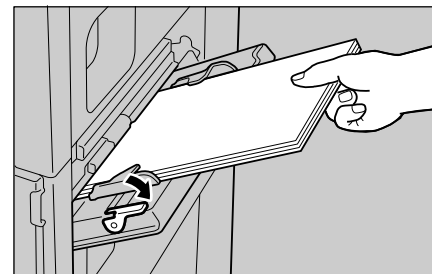

When Copying Onto Special Size Copy Paper

- ❑ Specify the size of copy paper to avoid paper jams.

❶ Press the **●** key.

- ❑ If you use the special size original, you should set the original in the document feeder first and input the original size. ⇒ See page 6.



❷ Enter the horizontal size of the paper with the **Number** keys and then press the **●** key.

- ❑ To change the number entered, press the **Clear/Stop** key, then enter the new number.

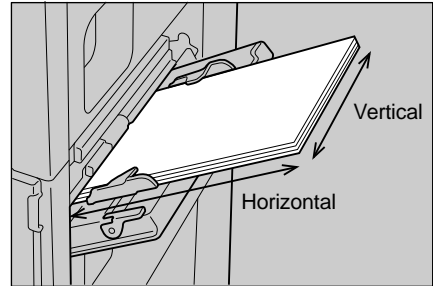

❸ Enter the vertical size with the **Number** keys and then press the **[OK]** key.

- ❑ If you start copying without pressing the **[OK]** key or if the entered size is different from the copy paper, the reverse side of the copy might be marked. Be sure to specify the size of the paper and press the **[OK]** key.

- ❑ After entering the size, **✕** appears on the panel display.

- ❑ If you have set the special size original in the document feeder, press the **[Orig. Size]** key and enter the original size. ⇒ See page 7.

- ❑ The entered size is not reset by turning off the main switch or pressing the **Clear Modes/Energy Saver** key. Re-entering size or canceling this setting reset the entered size. ⇒ See page 21.

❹ Set the originals and then press the **Start** key.

- ❑ When copying onto OHP transparencies, remove the copies one by one as they come out.

Canceling the special size paper setting

❶ Select **✕** (special paper size) with the **[Paper]** or the **◀ ▶** keys.

❷ Press the **●** key.

❸ Press the **[Cancel]** key.

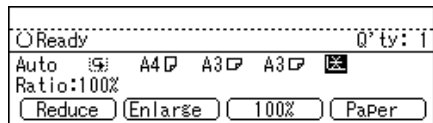

STORING YOUR COPY SETTINGS IN MEMORY (Program)

If there are certain combinations that you use frequently, you can store these settings as a program. Each time you need to perform this job, you only need to recall the program, saving time and trouble.

- ❑ You can store up to two programs.
- ❑ The size of copy paper can be memorized. Thus, if copy paper of the same size is set, the upper tray is selected.
- ❑ Programs are not cleared by turning the power off or by pressing the **Clear Modes/Energy Saver** key. It is canceled when you overwrite them with another program.
- ❑ You cannot erase a program. To change a program, overwrite it with a new one.
⇒ See “Storing/Changing the Program.”
- ❑ You cannot register the number of copies.

Storing/Changing The Program

1 Set the copy settings you want to store.

2 Press the **Program** key. The program screen is displayed.



3 Press the **[Store]** key.

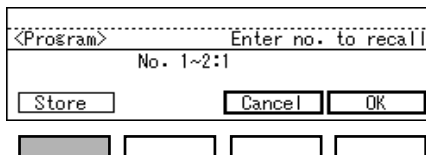

4 With the **◀** and **▶** keys, select a program number. Then, press the **[OK]** key.
When you finish, **↔** is displayed.

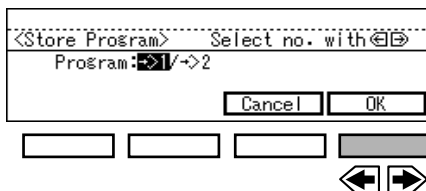

- ❑ The program number with **↔** has already settings in it.

When the program is already registered (Change)

- ❶ Check the program and then decide whether or not to overwrite it.
 - ⇒ To find out the stored settings, see “Recalling a Program.”
 - ❑ To overwrite the program, press the **[Yes]** key.
 - ❑ To cancel your selection, press the **[No]** key and then select an unregistered number.

Recalling A Program

- ❶ Press the **Program** key. The program screen is displayed.
- ❷ With the **Number** keys, enter the number of the program to be recalled. Then, press the **[OK]** key. The registered settings for the program are displayed.
 - ❑ A number without ↔ does not have settings in it.
- ❸ Set the original and then press the **Start** key.

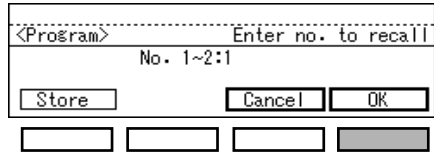

OTHER FUNCTIONS

Temporarily Stopping One Job To Copy Something Else (Interrupt)

You can make urgently needed copies during a multi-copy run.

- ❶ Press the **Interrupt** key. The key's indicator lights.
- ❷ Remove the originals currently set for copying, and set your originals for interrupt copying. Make your copies.

OTHER FUNCTIONS

3 After interrupt copying, remove the originals for interrupt copying and the copies.

4 Press the **Interrupt** key. The key's indicator goes out, and the previous copy job settings are recalled.

- Reset the previous originals.
- The previous copy job settings are left intact so the previous copy job can be resumed simply by pressing the **Start** key.

Entering Copy Job Settings During The Warm-up Period (Auto Start)

“Please wait” is displayed during the warm-up period after you turn the main switch on. If you enter the copy job settings and press the **Start** key during this period, the machine starts copying automatically when it reaches the ready condition.

- To cancel Auto Start, press the **Clear/Stop** key.
- After you enter the copy job settings and press the **Start** key, the indicator on the **Start** key blinks.
- Auto Start is impossible right after you add copy paper to the paper tray.

Original Beeper

The beeper sounds and a message is displayed when an operator forgets to remove originals from the exposure glass after copying. ⇒ See page 60.

REDUCING AND ENLARGING USING PRESET RATIOS (Reduce/Enlarge)

You can select a preset ratio for copying.

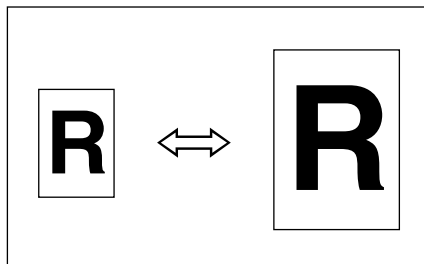

COPYING

◆Preset ratios for original sizes and copy paper sizes

Metric Version

Enlarging ratio (%)	Original → Copy paper size
400*1	
200*1	A5→A3 A6→A4 B6→B4
141	A4→A3 A5→A4 A6→A5 B5→B4 B6→B5
122	A4→B4 A5→B5 A6→B6
115	B4→A3 B5→A4 B6→A5

Reducing ratio (%)	Original size → Copy paper size
93	(for providing a margin on four sides of an original) 11" × 14" → B4*2
87	A3→B4 A4→B5 A5→B6
82	B4→A4 B5→A5 B6→A6
71	A3→A4 A4→A5 A5→A6 B4→B5 B5→B6
65	A3→F
50	A3→A5 A4→A6 B4→B6
25*3	

*1 This ratio is cannot be selected when the document feeder is used.

*2 Size (11" x 14") is a computer's printing paper size.

*3 This reproduction ratio cannot be selected when using Text/Photo or Photo mode, or cancelling the Memory Copy mode.

REDUCING AND ENLARGING USING PRESET RATIOS (Reduce/Enlarge)

Inch Version

Enlarging ratio (%)	Original → Copy paper size
400*1	
200*1	5½" x 8½" → 11" x 17"
155*1	5½" x 8½" → 8½" x 14"
129	8½" x 11" → 11" x 17"
121	8½" x 14" → 11" x 17"

Reducing ratio (%)	Original size → Copy paper size
93	(for providing a margin on four sides of an original)
85	F → 8½" x 11"
77	8½" x 14" → 8½" x 11"
74	11" x 15" → 8½" x 11"
65	11" x 17" → 8½" x 11"
50	11" x 17" → 5½" x 8½"
25*2	

*1 This ratio is cannot be selected when the document feeder is used.

*2 This reproduction ratio cannot be selected when using Text/Photo or Photo mode, or cancelling the Memory Copy mode.

- You can select a ratio regardless of the size of an original or copy paper. With some ratios, parts of image might not be copied and blank margins appears on copies.

1 Select a ratio with the **[Reduce]** or **[Enlarge]** key.

- Each time you press the key, the ratio changes.

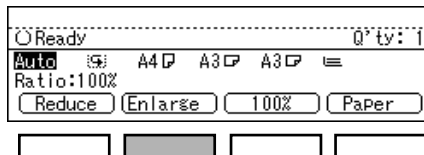

2 Set the original and then press the **Start** key.

REDUCING AND ENLARGING IN 1% STEPS (Zoom)

You can change the reproduction ratio in 1% steps.

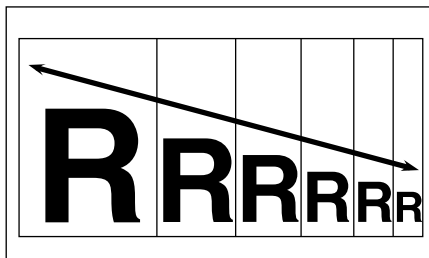

- ❑ The following ratios can be selected:

	Text mode in Memory Copy mode	Except the left case
Setting originals on the exposure glass	25~400%	50~400%
Setting originals in the document feeder	25~190%	50~190%

- ❑ You can select a preset ratio which is near the desired ratio, and then adjust it with the **+Zoom Up** or **-Zoom Down** key.

- 1 Specify the ratio with the **+Zoom Up** or **-Zoom Down** key. The specified ratio is displayed on screen.



- ❑ When you press the **+Zoom Up** or **-Zoom Down** key once, the ratio is changed in 1% steps. When you hold them down, the ratio is changed in 10% steps.
- ❑ If you make a mistake, correct the ratio with the **+Zoom Up** or **-Zoom Down** key.

- 2 Set the original and then press the **Start** key.

STRETCHING AND SQUEEZING THE IMAGE INTO THE COPY AREA (Directional Size Magnification)

The machine can reduce or enlarge copies to match independent horizontal and vertical size settings.

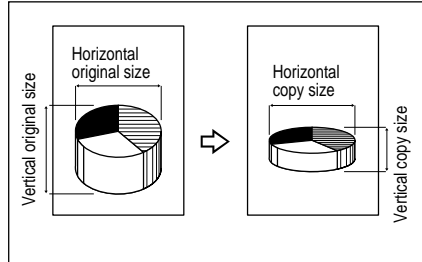

- Specify the vertical and horizontal sizes of the original and those of the copy, as shown in the illustration.
- The following ratios can be selected;

	Text mode in Memory Copy mode	Except the left case
Setting originals on the exposure glass	25~400%	50~400%
Setting originals in the document feeder	Horizontal: 25~190% Vertical: 25~400%	Horizontal: 50~190% Vertical: 50~400%

- If the calculated ratio is over the maximum or under the minimum ratio, it is corrected within the range of the ratio automatically.

1 Set the original.

2 Press the **D. Size Mag.** key. The setting screen is displayed.



3 Enter the horizontal original size with the **Number** keys. Then, press the **OK** or **▶** key.



- Acceptable values are as follows:
 - Metric version: 1 to 999 mm in 1 mm steps
 - Inch version: 0.1" to 99.9" in 0.1" steps
- If you make a mistake, press the **Clear/Stop** key and then enter the correct value.

4 Enter the horizontal copy size with the **Number** keys. Then, press the **●** or **➡** key.

If you press the **[OK]** key after entering horizontal original and copy size, the machine enters the size magnification (not directional) mode.

5 Enter the vertical original size with the **Number** keys. Then, press the **●** or **➡** key.

6 Enter the vertical copy size with the **Number** keys. Then, press the **[OK]** key.

To change the size, select the desired item with the **◀** or **➡** key and then enter the new size.

7 Press the **Start** key.

STRETCHING AND SQUEEZING THE IMAGE IN 1% STEPS (Directional Magnification(%))

The machine can reduce or enlarge copies at different reproduction ratios horizontally and vertically.

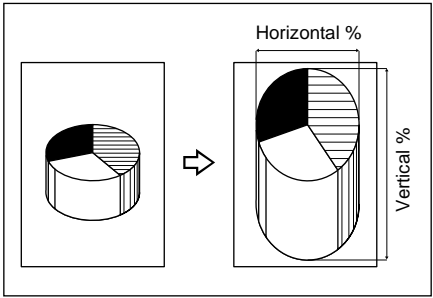

The following ratios are specifiable:

	Text mode in the Memory Copy mode	Except the left case
Setting originals on the exposure glass	25~400%	50~400%
Setting originals in the document feeder	Horizontal: 25~190% Vertical: 25~400%	Horizontal: 50~190% Vertical: 50~400%

1 Set the original.

STRETCHING AND SQUEEZING THE IMAGE IN 1% STEPS MAKING TWO-SIDED COPIES (Duplex)

- 2** Press the **Direct. Mag.(%)** key.
The setting screen is displayed.



- 3** Enter the horizontal ratio with the **Number** keys. Then, press the **●** or **▶** key.

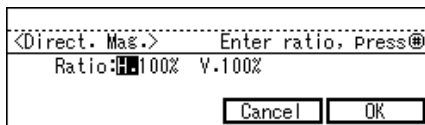

- You can also specify the ratio with the **+Zoom Up** or **-Zoom Down** keys.

- 4** Enter the vertical ratio with the **Number** keys. Then, press the **[OK]** key.

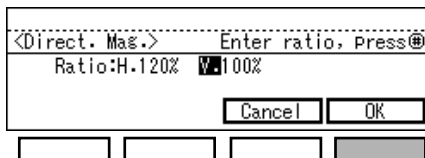

- If you make a mistake, press the **●**, **◀**, or **▶** key and then enter the correct value.

- 5** Press the **Start** key.

MAKING TWO-SIDED COPIES (Duplex) (Optional ARDF is Required for 2-Sided → 2-Sided Mode)

The machine can make a two-sided copy from two one-sided originals, one two-sided original or two facing pages of a bound original (book).

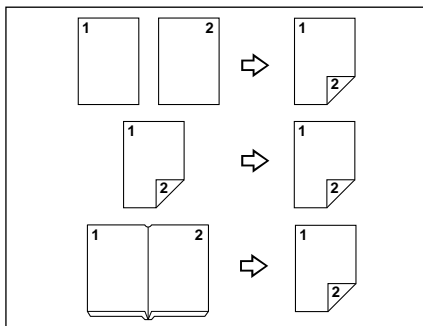

- ❑ There are three ways to make copies:
 - **1-sided → 2-sided**
The machine makes a two-sided copy from two one-sided originals.
 - **2-sided → 2-sided**
The machine makes a two-sided copy from a two-sided original.
 - **Book → 2-sided**
The machine makes a two-sided copy from two facing pages of a bound original (book).
- ❑ Book Original Sizes and 2-sided Copy Sizes (ratio=100%)

Metric version		Inch version	
Original	Copy paper	Original	Copy paper
A3 <input type="checkbox"/>	A4 <input type="checkbox"/> 2-sided	11" x 17" <input type="checkbox"/>	8½" x 11" <input type="checkbox"/> 2-sided
B4 <input type="checkbox"/>	B5 <input type="checkbox"/> 2-sided		
A4 <input type="checkbox"/>	A5 <input type="checkbox"/> 2-sided		

- ❑ The machine cannot make 2-sided copies using the following copy paper:
 - Paper smaller than A5
 - Translucent paper
 - Adhesive labels
 - OHP transparencies
 - Post cards
- ❑ You cannot use the bypass tray with this feature.
- ❑ The machine cannot rotate the image by 90° for copy paper when making a two-sided copy from two facing pages of a book. Select copy paper.
- ❑ A binding margin is set on the reverse side for copying. You can change the margin width and position. You can also change the default settings (5mm, 0.2" is default). ⇒ See page 61.

If you select 1-sided → 2-sided, observe the following notes:

- ❑ When setting the originals in the document feeder, the first page must be on top. If you set one original at a time, start with the first page to be copied.
- ❑ When setting the originals on the exposure glass, set the originals starting with the first page.
- ❑ If you set an odd number of 1-sided originals, the reverse side of the last page is left blank.

MAKING TWO-SIDED COPIES (Duplex)

- You can select an original direction (Top to Top/Top to Bottom). Align the top and bottom edges of originals when setting, as shown in the illustration.

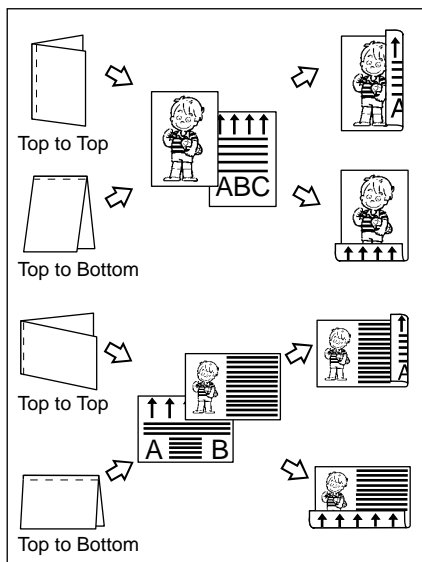

- Set A3, B4, 11" x 17" or 8½" x 14" originals as shown in the illustration.

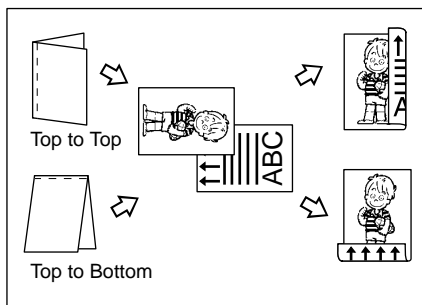

- Press the **Duplex** key. The setting screen is displayed.

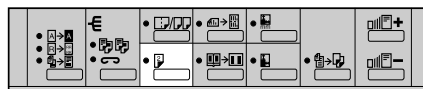

- Select one of Duplex modes with the **Left** or **Right** key.

- If you select **[2-sided → 2-sided]** or **[Book → 2-sided]**, press the **[OK]** key and go to step **6**.

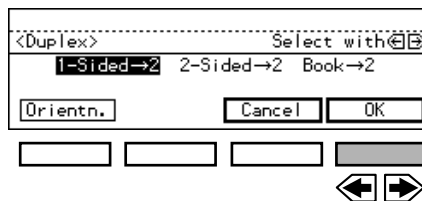

- Press the **[Orientn.]** key.

4 Select [**Top to Top**] or [**Top to Bottom**] with the ◀ or ▶ key. Then, press the [**OK**] key.

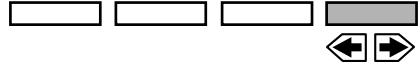
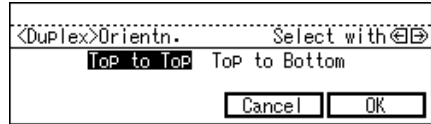

- Although you have canceled the Memory Copy mode, the Memory Copy Mode is automatically selected when you select the [**Top to Bottom**]. [**Top to Bottom**] is only available in the Memory Copy mode.

5 Press the [**OK**] key.

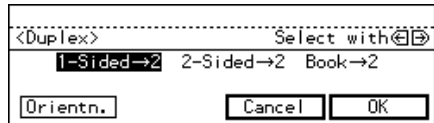

6 If you have selected Book → 2-sided in step **2**, select copy paper by pressing the [**Paper**] key. To do this, refer to the table on page 31.

7 Set the originals and then press the **Start** key.

- Regarding setting originals, see page 4.
- When you set the originals on the exposure glass or one original at a time in the document feeder, remove the first original after it is scanned and then repeat step **7**. To finish copying with the odd number of originals, press the ● key.
- If a copy is left on the duplex tray, a message is displayed. Press the **Start** key to exit the copy from the duplex tray.

You can select whether or not to automatically exit the last copy with the back side blank from the duplex tray. ⇒ See page 63.

MAKING ONE-SIDED COPIES FROM VARIOUS ORIGINALS (Series Copies) (Optional ARDF is Required for 2-Sided → 1-Sided Mode)

The machine can make two separate one-sided copies from one two-sided original or two facing pages of bound (book) originals.

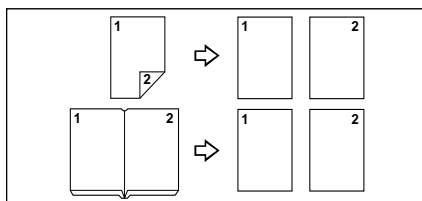

- ❑ Book Original Sizes and 1-sided Copy Sizes (ratio=100%)

Metric version		Inch version	
Original	Copy paper	Original	Copy paper
A3	A4 x 2	11" x 17"	8½" x 11" x 2
B4	B5 x 2		
A4	A5 x 2		

- ❑ You cannot use the bypass tray with this feature.

1 Press the **Combine/Series Copies** key. The setting screen is displayed.

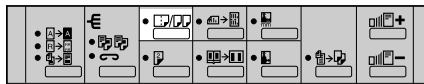

2 Press the [**Series**] key.



3 Select one of Series Copies modes with the or key. Press the [**OK**] key.

4 Press the [**Exit**] key.

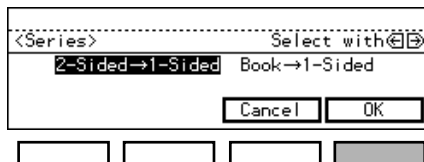

5 If you selected [Book → 1-sided] in step **3**, select copy paper by pressing the [**Paper**], or key.

6 Set the originals and then press the **Start** key.

COMBINING ORIGINALS INTO ONE COPY (Combine)

The machine can copy from multiple one-sided originals to one sheet of copy paper.

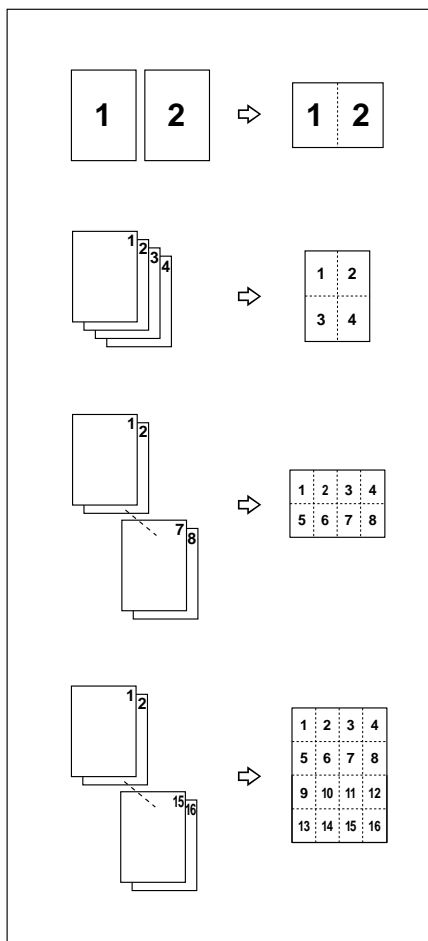

- The number of originals copied (combined) is 2, 4, 8, or 16.
- The machine can print a separation line between copied images. ⇒ See page 60.
- You can use this mode with the Duplex mode. The number of originals you input will be the number of images copied on the one side of the copy.

COMBINING ORIGINALS INTO ONE COPY (Combine)

◆Setting Originals

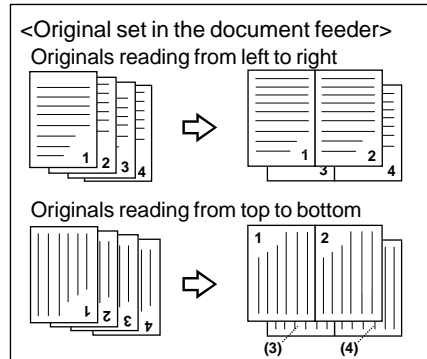

- The machine cannot copy originals different in size and direction.
- You cannot use the bypass tray with this feature.
- You can use both sideways (☐) and lengthwise (☐) originals. If you select 4 in 1, 8 in 1, or 16 in 1, even if the direction of originals in the document feeder is different from that of the copy paper, the machine will automatically rotate the image by 90° to make copies properly. However, if you use lengthwise (☐) originals in 2 in 1, the machine cannot rotate the copy image automatically. In this case, it is recommended to select 4 in 1.
- Copying is possible even if the number of originals in the document feeder is less than the specified number of originals to be combined.
You can change these default settings. ⇒ See page 63.
- If the number of originals is less than the number of originals to be combined, the copies can be made as shown in the illustration.

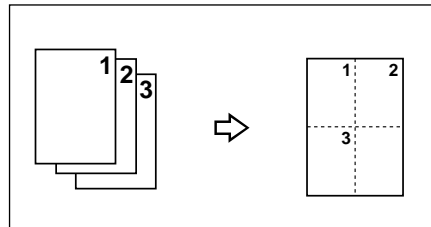

- The range of reproduction ratio you can select is from 25% to 190% when using the document feeder or auto reverse document feeder. So that, parts of original image are not copied in “8 in 1” and “16 in 1” modes. In this case, place originals on the exposure glass. All of original image can be copied.
- When using the Combine mode, you can select out of four modes: 2 in 1, 4 in 1, 8 in 1, and 16 in 1. However, when in Text/Photo or Photo mode, with 8 in 1 or 16 in 1, copy image may get coarser and darker.

1 Press the **Combine/Series Copies** key. The setting screen is displayed.

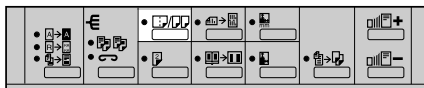

2 Press the **[Combine]** key.

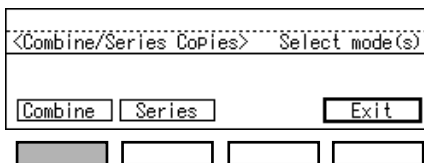

3 Enter the number of originals with the **Number** keys and then press the **[OK]** key.

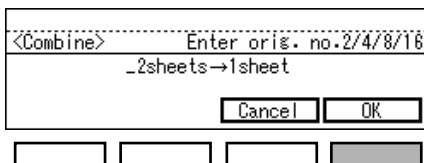

4 Press the **[Exit]** key.

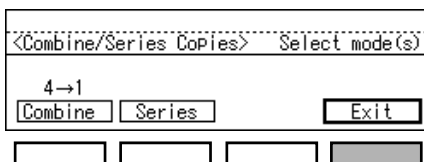

5 Select copy paper with the **[Paper]** or the **◀ ▶** key.

The Auto Reduce/Enlarge is selected automatically. You need not to select the reproduction manually.

6 Set the originals and then press the **Start** key.

- When you set the originals in the document feeder, the first page must be on top. If you set one original at a time, start with the first page.
- When you set the originals on the exposure glass, start with the first page.
- When you set the originals on the exposure glass or one original at a time in the document feeder, remove the first original after it is scanned. Then, repeat step **6**. To finish copying, press the **●** key and the **Start** key.

COPYING THE IMAGE TWICE ON ONE PAGE (Double Copies)

The machine can copy the one original image twice on one page as shown below. The separation line appears as a broken line by default.

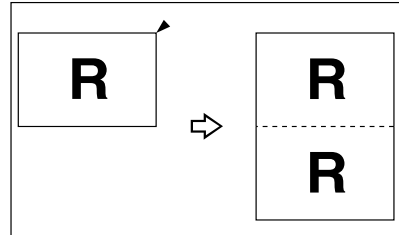

- It is impossible to turn lengthwise (☐) original images 90° on lengthwise (☐) copy paper. In this case, select ☐ copy paper referring to the table below.
- The machine cannot properly detect A5☐ and 5½" x 8½" ☐ originals on the exposure glass. Be sure to select the copy paper manually or set the originals in the document feeder (option).

Original size Setting originals	A5 ☐ (metric version only)	5½"x8½" ☐ (inch version only)
on the exposure glass	X	X
in the document feeder	○	○

- You can change the type of separation lines or eliminate the lines. ⇒ See page 62.

◆ Combinations of Originals and Copy Paper (ratio=100%)

Metric version

Original size and direction	Copy paper size and direction
A5 ☐	A4 ☐

Inch version

Original size and direction	Copy paper size and direction
5½" x 8½" ☐	8½" x 11" ☐

1 Press the **Double Copies** key.

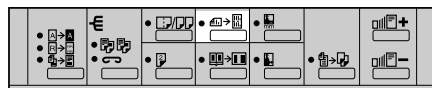

2 Set the original and then press the **Start** key.

ERASING THE CENTRE AND THE BORDER (Erase Centre/Border)

The machine can make copies of a book or magazine originals by erasing the shadow at the centre and/or four sides of copy paper.

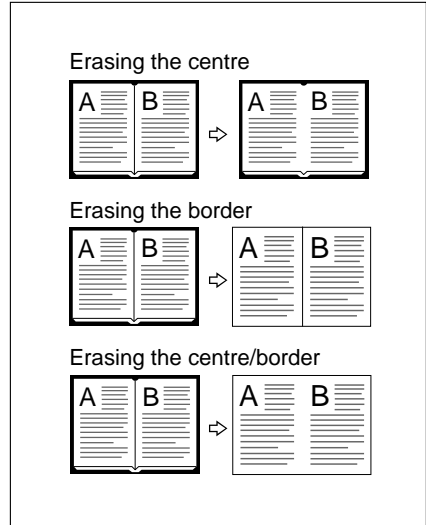

- There are three ways to make copies:
 - **Centre**
The machine erases the shadow at the center of copy paper.
 - **Border**
The machine erases the shadow at the four sides of copy paper
 - **Centre/Border**
The machine erases the shadow at the center and four sides of copy paper.

- The default setting of the margin width is as follows:
 - Metric version: 10 mm
 - Inch version: 0.4"

- You can specify the margin width as follows. Change the default settings to specify the margin position and width. ⇒ See page 61.
 - Metric version: 3 to 50 mm in 1 mm steps
 - Inch version: 0.1" to 2.0" in 0.1" steps

- Areas you do not want to delete might be erased if you use non-standard size paper.

- You cannot use the bypass tray with this feature.

ERASING THE CENTRE AND THE BORDER (Erase Centre/Border)

◆Direction and margin to be erased on copy paper

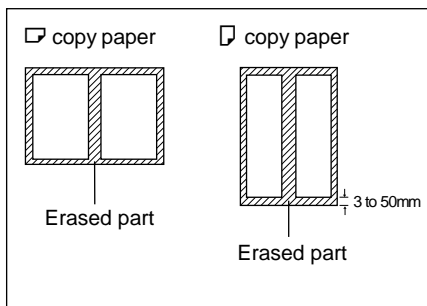

1 Press the **Erase Centre/Border** key. The setting screen is displayed.

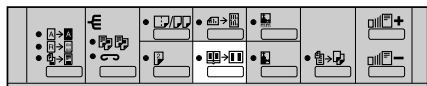

2 Press the key corresponding to the part to be erased.

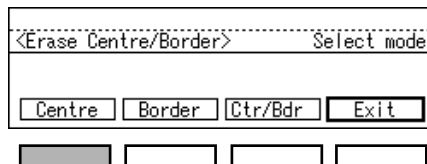

If You Have Pressed The (Centre) Key

1 Enter the center width with the **Number** keys and then press the **[OK]** key.

If you make a mistake, press the **Clear/Stop** key and then enter the correct value.

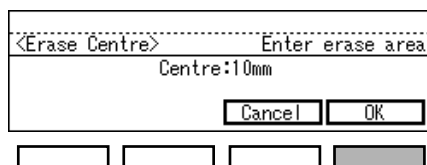

2 Press the **[Exit]** key.

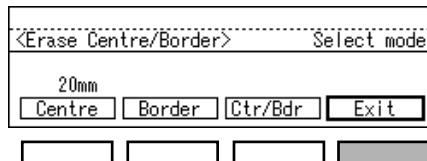

If You Have Pressed The (Border) Key

- ❶ Enter the border width with the **Number** keys and then press the **[OK]** key.
 - ❑ If you make a mistake, press the **Clear/Stop** key and then enter the correct value.
- ❷ Press the **[Exit]** key.

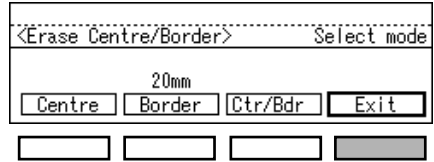
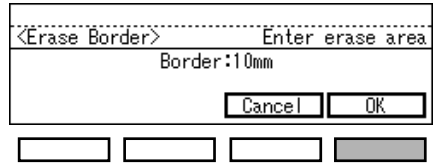

If You Have Pressed The (Ctr/Bdr) Key

- ❶ Enter the center width with the **Number** keys and then press the **●** or **➔** key.
 - ❑ If you make a mistake, press the **Clear/Stop** key and then enter the correct value.
- ❷ Enter the border width with the **Number** keys and then press the **[OK]** key.
 - ❑ If you make a mistake, press the **Clear/Stop** key and then enter the correct value.
- ❸ Press the **[Exit]** key.

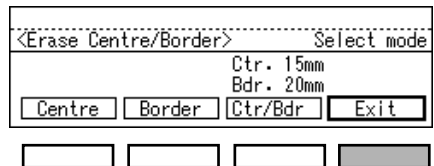
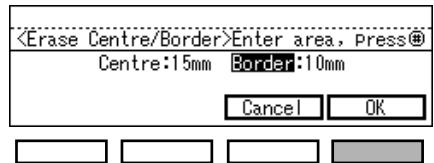

- ❸ Set the originals and then press the **Start** key.

EDITING THE COPY IMAGE

Reversing Black And White (Positive/Negative)

Black and white images of the original are reversed.

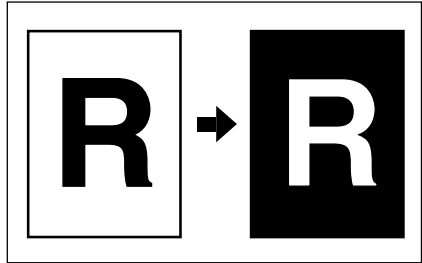

- ❑ You cannot use this function when you select 25% ~ 49% reproduction ratio.

1 Press the **Editing** key until the setting screen is displayed.



2 Select "Yes" with the **◀ ▶** keys and press the **[OK]** key.

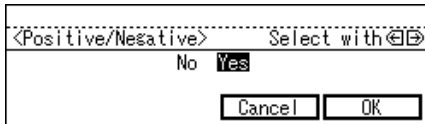

3 Set the originals and press the **Start** key.

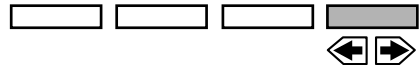

Repeating An Image Over The Entire Copy (Repeat)

The original image is copied repeatedly.

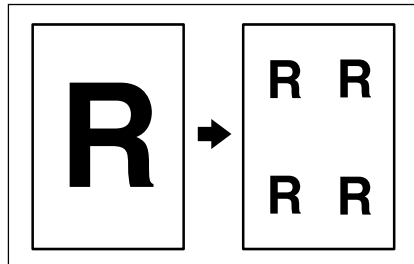

- ❑ The number of repeated images depends on the original size, copy paper size, and reproduction ratio. Refer to the table on page 43.
- ❑ You cannot use this function when you select 25% ~ 49% reproduction ratio.
- ❑ You cannot use the bypass tray with this feature.
- ❑ Part of a repeated image might not be copied depending on copy paper size, copy paper direction, or reproduction ratio.
- ❑ Separate lines between repeated images can be printed using the user tools.
⇒ See page 62.

◆ **Original size, copy paper size, reproduction ratio, and number of repeated images**

Metric version:

Original size	Copy paper size	Reproduction ratio and number of repeated images
A5	A4	71% → 4 images
A5	A4	35% → 16 images
A5	A4	100% → 2 images
A5	A4	50% → 8 images 25% → 32 images

Inch version:

Original size	Copy paper size	Reproduction ratio and number of repeated images
5½"x8½"	8½"x11"	65% → 4 images
5½"x8½"	8½"x11"	32% → 16 images
5½"x8½"	8½"x11"	100% → 2 images
5½"x8½"	8½"x11"	50% → 8 images 25% → 32 images

□ If you use the Text/Photo or Photo mode, the minimum reproduction ratio you can select is 50%.

1 Press the **Editing** key until the setting screen is displayed.



2 Select "Yes" with the **Left** and **Right** keys and press the **[OK]** key.

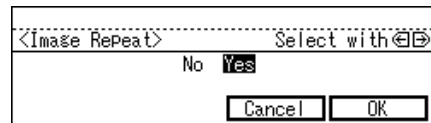

3 Select the copy paper size with **[Paper]**, **Left**, or **Right** key.



□ If you want to change the reproduction ratio, change it referring to the above tables.

4 Set your originals and press the **Start** key.

Merging Images (Overlay)

The machine can merge two different originals onto the same copy paper.

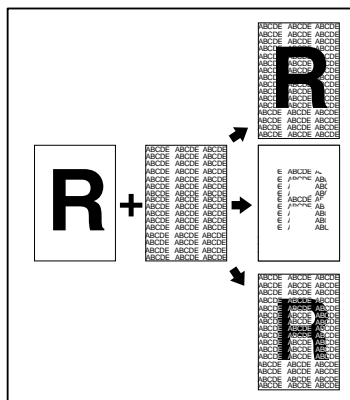

- There are three ways to make Overlay copy.
 - Overlay-1
Two different originals can be merged onto the same copy paper.
 - Overlay-2
The machine merges two originals and only the overlapped image will be copied.
 - Overlay-3
Originals are merged and where black overlaps black, the image is inverted (see the above illustration).

- You cannot use this function when you select 25% ~ 49% reproduction ratio.

1 Press the **Editing** key until the setting screen is displayed.



2 Select "Overlay-1", "Overlay-2" or "Overay-3" with the ◀ ▶ keys. Then press the [OK] key.

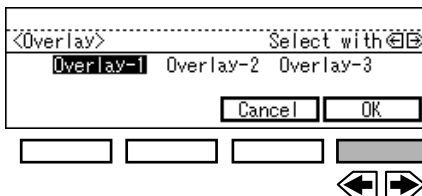

3 Set the originals and press the **Start** key.

- When you set originals on the exposure glass, start with the first page to be copied. After the first original is scanned, remove originals and repeat step **3**.

STAPLING (Optional Finisher is Required)

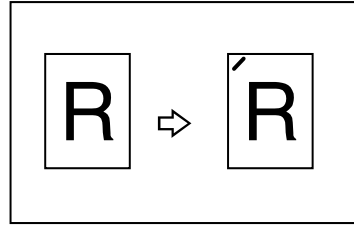

- ❑ For this mode, the following limitations apply:

Metric version:

Paper Size	Paper weight		Stapler Capacity	Shift tray capacity
A4	Maximum	Minimum	from 2 to 20 sheets	30 sets (80 g/m ²)
	80 g/m ²	64 g/m ²		

Inch Version:

Paper Size	Paper weight		Stapler Capacity	Shift tray capacity
8½"x11"	Maximum	Minimum	from 2 to 20 sheets	30 sets (20 lb)
	20 lb	17 lb		

- ❑ Post cards, tracing paper, OHP sheets, and adhesive labels, and paper that is curled or low stiffness cannot be used.
- ❑ Copy paper with different sizes and directions cannot be stapled.
- ❑ If the number of copies is over the stapler capacity, the copies will be delivered to the shift tray without stapling.
- ❑ To avoid problems caused by curled copies, load paper with the copy side down in the paper tray. If copies are curled, try turning the copy paper over in the tray. If there is no improvement, change to copy paper with less curl.
- ❑ If "Add Staples" is displayed during copying, copies might be delivered to the shift tray without stapling. ⇒ Regarding how to add staples, see "ADDING STAPLES" in the "General Reference".

Stapling Position And Original Setting

When you set originals in the Staple mode, refer to the following table.

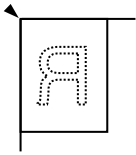
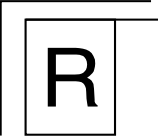
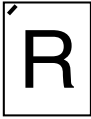
Original setting		Copies
on the exposure glass	in the document feeder	
		

- 1 Press the **Sorter** key to light the **Staple** (lower) indicator.



- 2 Enter the number of copies and any settings you require.

When setting originals one at a time on the exposure glass or in the document feeder

- 1 Set the original and then press the **Start** key.
 - Start with the first page to be copied.
- 2 Set the next original and press the **Start** key.
 - Set the originals in the same direction as step 1.
 - When the remaining memory space reaches 0%, the machine stops memorizing. Press the **[Output]** key to finish copy jobs which are already in memory. In this case, copies will be delivered without stapling. Continue copying by following the instruction on the panel display. If you want to delete the stored images, press the **[Clear]** key.
- 3 When the machine finishes scanning all the originals, press the ● key.
- 4 Press the **Start** key. The copies will be delivered.

When setting a stack of originals in the document feeder

- ❶ Set the originals and press the **Start** key.
When the machine finishes scanning, copies are automatically delivered.
- ❑ The first page must be on top.
- ❑ When the remaining memory space reaches 0%:
 - The machine stops scanning originals.
 - Press the **[Output]** key to finish copy jobs which are already into memory. Remove copies from the shift tray and continue copying following the instructions on the panel display.
 - If you press the **[Clear]** key, the copy jobs which have been stored will be cleared, and copying stops.

COMBINATION CHART

- : means that these modes can be used together.
- ×: means that these modes cannot be used together. The mode before you select will be the mode you're working in.
- : means that these modes cannot be used together. The mode after you select will be the mode you're working in.

The following shows the combinations of functions.

Mode before you select		Mode after you select																					
		Reduce/Enlarge, Zoom	Directional Size Magnification		Duplex		Series Copies		Combine		Double Copies		Erase Centre/Border	Auto Paper Select	Copying from the Bypass Tray	Auto Reduce/Enlarge	Sort/Rotate Sort	Editing		Stapling (option)	Special size originals	Selecting Original Type (Text/Photo, Photo)	
Reduce/Enlarge, Zoom		●	○	○	○	○	○	○	○	○	○	○	○	○	○	○	○	○	○	○	○	○	○
Directional Size Magnification	1-sided → 2-sided	○	○	○	○	○	○	○	○	○	○	○	○	○	○	○	○	○	○	○	○	○	○
	2-sided → 2-sided	○	○	○	○	○	○	○	○	○	○	○	○	○	○	○	○	○	○	○	○	○	○
Duplex	Book → 2-sided	○	○	○	○	○	○	○	○	○	○	○	○	○	○	○	○	○	○	○	○	○	○
	Book → 1-sided	○	○	○	○	○	○	○	○	○	○	○	○	○	○	○	○	○	○	○	○	○	○
Series Copies	2-sided → 1-sided	○	○	○	○	○	○	○	○	○	○	○	○	○	○	○	○	○	○	○	○	○	○
	Book → 1-sided	○	○	○	○	○	○	○	○	○	○	○	○	○	○	○	○	○	○	○	○	○	○
Combine	2 in 1	○	○	○	○	○	○	○	○	○	○	○	○	○	○	○	○	○	○	○	○	○	○
	4 in 1, 8 in 1, 16 in 1	○	○	○	○	○	○	○	○	○	○	○	○	○	○	○	○	○	○	○	○	○	○
Double Copies		○	○	○	○	○	○	○	○	○	○	○	○	○	○	○	○	○	○	○	○	○	○
Erase Centre/Border		○	○	○	○	○	○	○	○	○	○	○	○	○	○	○	○	○	○	○	○	○	○
Auto Paper Select		○	○	○	○	○	○	○	○	○	○	○	○	○	○	○	○	○	○	○	○	○	○
Copying from the Bypass Tray		○	○	○	○	○	○	○	○	○	○	○	○	○	○	○	○	○	○	○	○	○	○
Auto Reduce/Enlarge		○	○	○	○	○	○	○	○	○	○	○	○	○	○	○	○	○	○	○	○	○	○
Sort/Rotate Sort		○	○	○	○	○	○	○	○	○	○	○	○	○	○	○	○	○	○	○	○	○	○
Editing	Positive/Negative	○	○	○	○	○	○	○	○	○	○	○	○	○	○	○	○	○	○	○	○	○	○
	Repeat	○	○	○	○	○	○	○	○	○	○	○	○	○	○	○	○	○	○	○	○	○	○
	Overlay	○	○	○	○	○	○	○	○	○	○	○	○	○	○	○	○	○	○	○	○	○	○
Stapling (option)		○	○	○	○	○	○	○	○	○	○	○	○	○	○	○	○	○	○	○	○	○	○
Special size originals		○	○	○	○	○	○	○	○	○	○	○	○	○	○	○	○	○	○	○	○	○	○
Interrupt		○	○	○	○	○	○	○	○	○	○	○	○	○	○	○	○	○	○	○	○	○	○
Selecting original type (Text/Photo, Photo)		○	○	○	○	○	○	○	○	○	○	○	○	○	○	○	○	○	○	○	○	○	○

*1: Only the Erase Border mode can be used together.

*2: Only the Sort mode can be used together.

*3: Special size originals longer than 433mm (17.1") cannot be used with these modes. Mode before you select takes priority.

*4: You cannot select 25% ~ 49% reproduction ratio.



WHAT TO DO IF SOMETHING GOES WRONG

IF YOUR COPIER DOES NOT START	50
IF YOU CANNOT MAKE CLEAR COPIES	51
IF YOU CANNOT MAKE COPIES AS YOU WANT	53

IF YOUR COPIER DOES NOT START

◆When Messages are Displayed

This is a summary of important messages. If a message not listed here is displayed, take corrective action by following the instructions in the message.

Message	Problem/cause	Corrective action
<input type="checkbox"/> Please wait.	<ul style="list-style-type: none"> This message is displayed after turning the main switch on, adding toner, or replacing the PCU. 	<ul style="list-style-type: none"> Wait for the machine to warm-up. You can make the copy job settings. ⇒ See "Auto Start" on page 24. If you turn the main switch on, you have to wait about 40 seconds until the machine can make copies. The machine initialize about 3 minutes after adding toner. The machine initialize about 2 minutes after replacing the PCU.
<input type="checkbox"/> Cannot detect orig. size.	<ul style="list-style-type: none"> Improper original is set. ⇒ See page 3. 	<ul style="list-style-type: none"> If non-standard size original is set, select copy paper by using the [Paper] key rather than by using Auto Paper Select. Do not use the Auto Reduce/Enlarge. Set originals on the exposure glass, or enter the non-standard original size ⇒ See pages 4 and 7.
	<ul style="list-style-type: none"> Original is not set. 	<ul style="list-style-type: none"> Set the original.
<input type="checkbox"/> Check orig. direct.	<ul style="list-style-type: none"> There is no copy paper that is the same direction as the originals. 	<ul style="list-style-type: none"> Set the original in the same direction as the copy paper.
		<ul style="list-style-type: none"> Pressing the Start key to copy the image to the selected copy paper.
<input type="checkbox"/> Check paper size.	<ul style="list-style-type: none"> There is no copy paper that matches the reproduction ratio. 	<ul style="list-style-type: none"> Check the paper size, and select the proper paper size.
<input type="checkbox"/> Cannot sort this size paper.	—	<ul style="list-style-type: none"> Check the copy paper size that can be used for the Sorting. For large paper sizes, the optional memory unit is required.
<input type="checkbox"/> Max. quantity: ##.	<ul style="list-style-type: none"> The number of copies exceeds the limit. 	<ul style="list-style-type: none"> You can change the limit on the number of copies which can be made at a time. ⇒ See page 60.
<input type="checkbox"/> Maximum stapling is 20 sheets.	<ul style="list-style-type: none"> The number of copies exceeds the stapler capacity. 	<ul style="list-style-type: none"> Check the stapler capacity. ⇒ See page 45.
<input type="checkbox"/> Cannot staple this size paper.	<ul style="list-style-type: none"> You select the copy paper that cannot be stapled. 	<ul style="list-style-type: none"> A4  and 8½" × 11"  can be stapled. Re-select the copy paper.

**IF YOUR COPIER DOES NOT START
IF YOU CANNOT MAKE CLEAR COPIES**

Message	Problem/cause	Corrective action
<input type="checkbox"/> Reset the Duplex Tray.	—	· Reset the duplex tray (unit) correctly. ⇒ See page viii.
<input type="checkbox"/> Reset the LCT		· Reset the large capacity tray correctly.
<input type="checkbox"/> Close the LCT cover		· Close the cover of the large capacity tray.
<input type="checkbox"/> Service Call.This function is not available. Press Cancel exit.	· The machine has a problem.	· Press the [Cancel] key. Call your service representative.

◆Others

<input type="checkbox"/> Panel display is invisible.	· The Energy Save mode is set.	· Press Clear Modes/Energy Saver key to cancel the Energy Save mode.
	· The main switch is turned off.	· Turn on the main switch.
<input type="checkbox"/> The machine does not work after turning on the main switch.	—	· Turn on the AC switch. ⇒ See page viii.

**WHAT TO DO IF SOME-
THING GOES WRONG**

IF YOU CANNOT MAKE CLEAR COPIES

The following shows the causes of unclear copies and corrective actions.

Problem	Cause	Corrective action
<input type="checkbox"/> Copies appear dirty.	· Image density is too dark.	· Adjust the image density. ⇒ See page 11.
	· Auto image Density is not selected.	· Select Auto Image Density.
<input type="checkbox"/> Reverse side of an original image is copied.	· Image density is too dark.	· Adjust the image density. ⇒ See page 11.
	· Auto Image Density is not selected.	· Select Auto Image Density.
<input type="checkbox"/> A shadow appears on copies if you use the pasted originals.	· Image density is too dark.	· Adjust the image density. ⇒ See page 11. · Change the setting direction of the original. · Put mending tape on the pasted part.

IF YOU CANNOT MAKE CLEAR COPIES

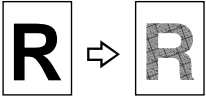
Problem	Cause	Corrective action
<input type="checkbox"/> Something other than the original image is copied.	<ul style="list-style-type: none"> Exposure glass, platen cover, or document feeder belt are dirty. 	<ul style="list-style-type: none"> Clean the exposure glass, platen cover, and document feeder belt. ⇒ See "MAINTAINING YOUR MACHINE" in "General Reference".
<input type="checkbox"/> Copies are too light.	<ul style="list-style-type: none"> Image density is too light. 	<ul style="list-style-type: none"> Select Auto Image Density. Adjust the image density. ⇒ See page 11.
	<ul style="list-style-type: none"> Improper copy paper is set. 	<ul style="list-style-type: none"> If you copy onto rough grain paper, paper with a processed surface, or dump paper, the copy might be too light. Change to dry, and undamaged paper.
	<ul style="list-style-type: none"> Toner cartridge is almost empty. 	<ul style="list-style-type: none"> Replace the toner cartridge with a new one. ⇒ See "ADDING TONER" in "General Reference".
<input type="checkbox"/> Parts of the image are not copied.	<ul style="list-style-type: none"> Original is not set in the correct location. 	<ul style="list-style-type: none"> Set the original correctly. ⇒ See page 4.
	<ul style="list-style-type: none"> Improper paper size is selected. 	<ul style="list-style-type: none"> Select the proper paper size. ⇒ See page 13.
<input type="checkbox"/> Copies are blank.	<ul style="list-style-type: none"> Original is not set correctly. 	<ul style="list-style-type: none"> Set the original face down on the exposure glass. Set the original face up in the document feeder. ⇒ See page 5.
<input type="checkbox"/> Moire pattern is produced on copies.	<ul style="list-style-type: none"> Your original has dot pattern image or many lines. 	<ul style="list-style-type: none"> Sometimes, a moire pattern can be prevented by changing the setting direction of the original.
		

IF YOU CANNOT MAKE COPIES AS YOU WANT

Problem	Cause	Corrective action
<input type="checkbox"/> Misfeeds occur frequently.	• Paper size setting is incorrect.	• Set the correct paper size using the user tools. ⇒ See “CHANGING THE PAPER SIZE” in “General Reference”.
<input type="checkbox"/> Some of the selected functions are unavailable.	• Selected functions cannot be combined.	• Check the combination of functions. Select the appropriate functions. ⇒ See page 48.
<input type="checkbox"/> In Double Copies mode, parts of the original image are not copied.	• Combination of original and copy paper is not correct.	• Select the proper original and copy paper. ⇒ See page 38.
<input type="checkbox"/> In Centre/Border mode, parts of the original image are not copied.	• Margin is too wide.	• Set the narrower margin using the user tools. ⇒ See “Erase Border” on page 61. ⇒ See “Erase Centre” on page 61.
	• Margin of your original is too narrow.	
<input type="checkbox"/> Parts of the original image are not copied when making 2-sided copies.	• Binding margin is too wide. • Margin opposite to the binding margin is too narrow.	• Set the narrower margin. ⇒ See page 61.

◆Combine

Problem	Cause	Corrective action
<input type="checkbox"/> Parts of the image are not copied or parts of the copy paper are blank.	• Your set originals are not identical in size and direction.	• It is impossible to combine originals as they are not identical in size and direction. Copy these originals with the same size paper, set copies which are identical in size and direction, and then select Combine.
<input type="checkbox"/> Order of copies is not correct.	• Your set originals are in incorrect order.	• When you set a stack of originals in the document feeder, the first page must be on top. When you set an original on the exposure glass, start with the first page to be copied.

◆Duplex

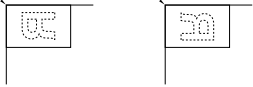
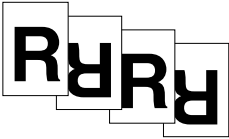
Problem	Cause	Corrective action
<input type="checkbox"/> Order of copies is not correct.	<ul style="list-style-type: none"> Your originals are set in incorrect order. 	<ul style="list-style-type: none"> When you set a stack of originals in the document feeder, the first page must be on top. When you set an original on the exposure glass, start with the first page to be copied.
<input type="checkbox"/> Orientation of copies (Top to Top, Top to Bottom) is not correct.	<ul style="list-style-type: none"> Your originals are set in incorrect direction. 	<ul style="list-style-type: none"> Align the top of originals to the rear scale. ⇒ See page 30. <input type="checkbox"/> You can set B4, 8½×14" or larger originals as follows. <div style="text-align: center;">  </div> <p>When doing this, take action ❶ or ❷.</p> <ul style="list-style-type: none"> ❶ Select "Top to Bottom" to make copies in "Top to Top" orientation. Select "Top to Top" to make copies in "Top to Bottom" orientation. ❷ Alternate the originals as shown below when setting them. <div style="text-align: center;">  </div>

◆Stapling

Problem	Cause	Corrective action
<input type="checkbox"/> Copies are not stapled.	<ul style="list-style-type: none"> After loading a new staple cartridge, staples might not be ejected the first few times you try to use the stapler. 	
	<ul style="list-style-type: none"> A few sheets might not be stapled. To correct this, try turning over the paper stack in the paper tray. If there is not improvement, change to copy paper with less curl. 	
	<ul style="list-style-type: none"> There are jammed staples in the stapler. 	<ul style="list-style-type: none"> Remove jammed staples. ⇒ See "REMOVING JAMMED STAPLES" in the "General Reference".
	<ul style="list-style-type: none"> The number of copies exceeds the capacity of the stapler. 	<ul style="list-style-type: none"> Check the stapler capacity. ⇒ See page 45.

CHANGING THE MACHINE'S SETTINGS

ACCESSING THE USER TOOLS (COPY FEATURES)	56
Returning To Copy Mode	57
USER TOOLS MENU (COPY FEATURES)	58
SETTINGS YOU CAN CHANGE WITH THE USER TOOLS	59
General Features 1/2	59
General Features 2/2	60
Adjust Image 1/2	61
Adjust Image 2/2	62
Input/Output 1/2	63
Input/Output 2/2	64
SERVICE REPRESENTATIVE SETTINGS	64

ACCESSING THE USER TOOLS (COPY FEATURES)

The User Tools allows you to change the default values for each function and to customize the machine's operation so it matches your most frequent needs.

- ❑ Change the default settings when the machine is in a different mode from the normal copy mode. After that, be sure to return the machine to normal copy mode.
- ❑ The stored settings are not canceled by turning the power off or by pressing the **Clear Modes/Energy Saver** key.
- ❑ For information about the user tools for system setting, see "CHANGING THE MACHINE'S SETTINGS" in "General Reference."
- ❑ For information about the settings for the optional fax and printer modes, see each Operating Instructions.

◆Key operations

- ❑ Pressing the [↑Prev.] or [↓Next] key changes the screen.
- ❑ Pressing the [PrevMenu] key returns to the previous menu.

1 Make sure that the machine is ready for copying.

- ❑ If the Copy mode display is not displayed, press the **Copy** key.

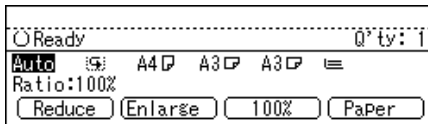

2 Press the **User Tools** key. The User Tools Main Menu screen is displayed.

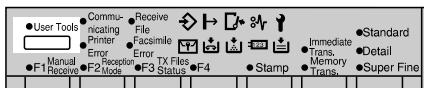

3 Press the [**Copy**] key. The Copy Features screen is displayed.

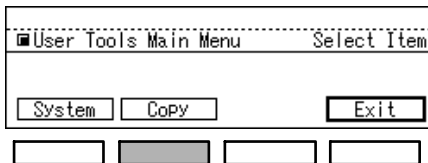

4 Enter the number of the item that you want to change settings with the **Number** key.

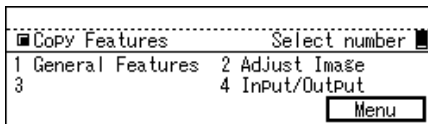

5 Search for the setting you want to change with the [**↓Next**] key. Enter its number with the **Number** key.
 ⇒ See “USER TOOLS MENU (COPY FEATURES)” on page 58.

6 Change the default settings by following the instructions in the display message. Then, press the [**OK**] key.

- ❑ ⇒ See “SETTINGS YOU CAN CHANGE WITH THE USER TOOLS” on page 59.
- ❑ Pressing the [**OK**] key sets the new settings and returns you to the previous selection screen.
- ❑ Pressing the [**Cancel**] key cancels the new settings and returns you to the previous selection screen.

Returning To Copy Mode

1 Press the **User Tools** key after changing the default settings. The machine returns to the Copy mode.

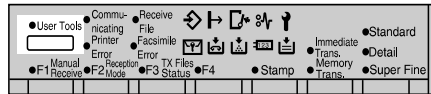

- ❑ You can also returns to the Copy mode by pressing the [**Exit**] key on the User Tools Main Menu screen.

USER TOOLS MENU (COPY FEATURES)

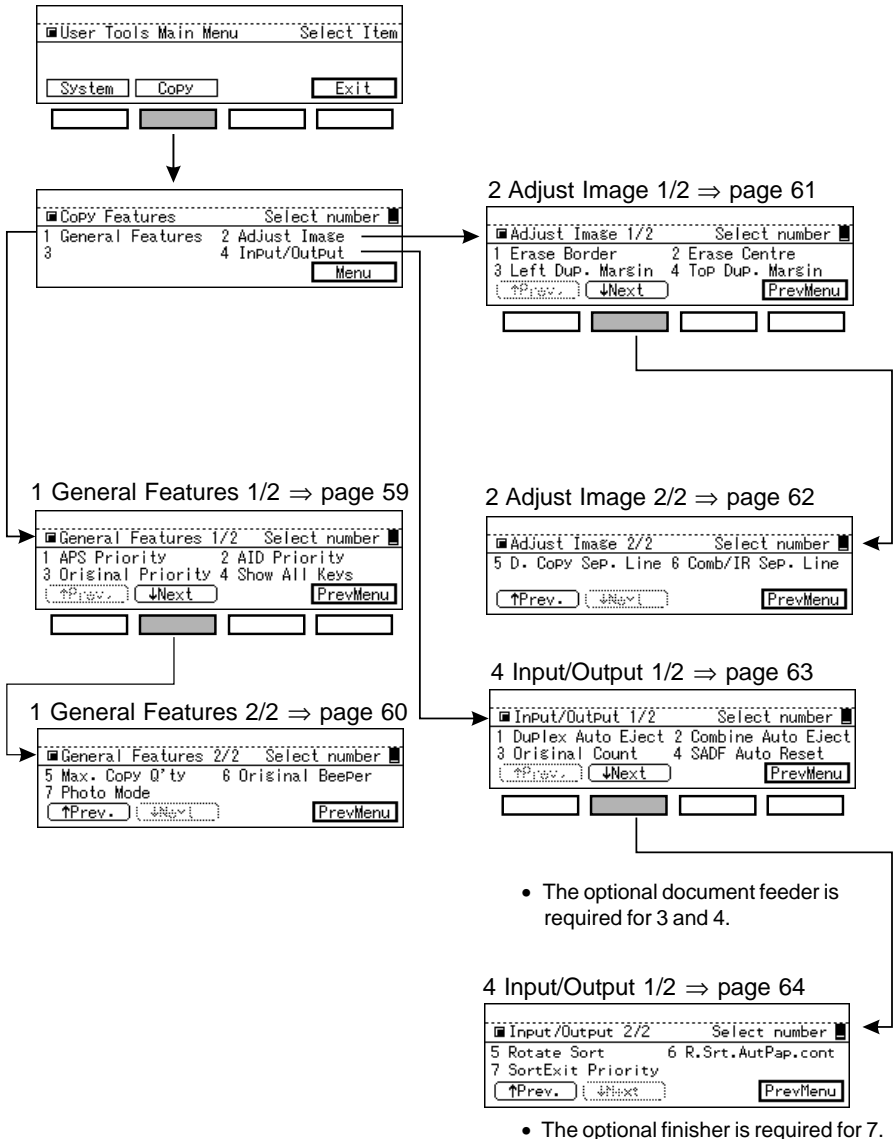

SETTINGS YOU CAN CHANGE WITH THE USER TOOLS

- For details on accessing the user tools, ⇒ see page 56.
- Shaded items () are selected as the default setting.

General Features 1/2

Description	Procedure
<p>1 APS Priority (Auto Paper Select Priority)</p> <ul style="list-style-type: none"> · As a default setting, Auto Paper Select is selected when the power is turned on, or modes are reset. You can cancel this setting. 	<ol style="list-style-type: none"> ❶ Select “No” or “Yes” with the or key. ❷ Press the [OK] key.
<p>2 AID Priority (Auto Image Density Priority)</p> <ul style="list-style-type: none"> · “Text” If you do not press the Original Type key, Text mode is selected as a default. With this user tool, you can select/cancel the Auto Image Density with Text mode. If you select “Yes” (Auto Image Density is selected), this is useful for copying originals with dirty backgrounds. * This setting is also applied to the Text/Photo mode. · “Photo” As a default, Auto Image Density is not selected when you select Photo mode with the Original Type key. You can cancel this setting. 	<ol style="list-style-type: none"> ❶ Select “Text” or “Photo” with the or key. ❷ Press the [OK] key. ❸ Select “No” or “Yes” with the or key. ❹ Press the [OK] key.
<p>3 Original Priority</p> <ul style="list-style-type: none"> · Changes the type of originals to be selected when the power is turned on or when modes are cleared. 	<ol style="list-style-type: none"> ❶ Select a type of originals with the or key. “Text”, “Photo” or “Text / Photo” ❷ Press the [OK] key.
<p>4 Show All Keys</p> <ul style="list-style-type: none"> · When “Yes”, [Reduce], [Enlarge] and [100%] keys, and paper sizes in the trays are shown on the display. When “No”, the keys are hidden as below. 	<ol style="list-style-type: none"> ❶ Select “No” or “Yes” with the or key. ❷ Press the [OK] key.

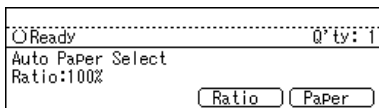

[Go to next page.]

SETTINGS YOU CAN CHANGE WITH THE USER TOOLS

- For details on accessing the user tools, ⇒ see page 56.
- Shaded items () are selected as the default setting.

General Features 2/2

Description	Procedure
<p>5 Max. Copy Q'ty (Maximum Copy Quantity)</p> <ul style="list-style-type: none">· The maximum copy quantity can be set between 1 and 99.	<ol style="list-style-type: none">❶ Enter the number with the Number keys.· The entry value must be from 1 to 99.❷ Press the [OK] key.
<p>6 Original Beeper</p> <ul style="list-style-type: none">· Specifies whether or not to sound the beeper to tell you that an original is left on the exposure glass.<input type="checkbox"/> If the Panel Beeper is set to OFF, this function does not come effect. ⇒ See "SETTINGS YOU CAN CHANGE WITH THE USER TOOLS" of "General Reference".	<ol style="list-style-type: none">❶ Select "Off" or "On" with the ◀ or ▶ key.❷ Press the [OK] key.
<p>7 Photo Mode</p> <ul style="list-style-type: none">· You can select the resolution when you select the Photo mode by Original Type key.	<ol style="list-style-type: none">❶ Enter 1 or 2 with Number keys. "1:Memory Copy:On" "2:Memory Copy:Off"❷ Select "Fine", "Normal", or "Coarse" with the ◀ or ▶ key. Memory Copy On : Fine Memory Copy Off : Normal❸ Press the [OK] key.

- ❑ For details on accessing the user tools, ⇒ see page 56.
- ❑ Shaded items () are selected as the default setting.

Adjust Image 1/2













Description	Procedure
<p>1 Erase Border</p> <ul style="list-style-type: none"> · Changes the width of the border to be erased in Erase Border mode. ⇒ See page 39. 	<p>❶ Enter the width with the Number keys. The width can be changed as follows:</p> <ul style="list-style-type: none"> · Metric version: 3 to 50 mm in 1 mm steps. (10 mm) · Inch version: 0.1" ~ 2.0" in 0.1" steps (0.4") <p>❷ Press the [OK] key.</p>
<p>2 Erase Centre</p> <ul style="list-style-type: none"> · Changes the width of the center to be erased in Erase Centre mode. ⇒ See page 39. 	<p>❶ Enter the width with the Number keys. The width can be changed as follows:</p> <ul style="list-style-type: none"> · Metric version: 3 to 50 mm in 1 mm steps. (10 mm) · Inch version: 0.1" ~ 2.0" in 0.1" steps (0.4") <p>❷ Press the [OK] key.</p>
<p>3 Left Dup. Margin (Left Duplex Margin) (optional duplex tray required)</p> <ul style="list-style-type: none"> · Changes the left binding margin on the reverse side when you make two-sided copies from one-sided originals. ⇒ See page 30. 	<p>❶ Enter the width with the Number keys. The width can be changed as follows:</p> <ul style="list-style-type: none"> · Metric version: 0 to 50 mm in 1 mm steps. (5 mm) · Inch version: 0 ~ 2.0" in 0.1" steps (0.2") <p>❷ Press the [OK] key.</p>
<p>4 Top Dup. Margin (Top Duplex Margin) (optional duplex tray required)</p> <ul style="list-style-type: none"> · Changes the top binding margin on the reverse side when you make two-sided copies from one-sided originals. ⇒ See page 30. 	<p>❶ Enter the width with the Number keys. The width can be changed as follows:</p> <ul style="list-style-type: none"> · Metric version: 0 to 50 mm in 1 mm steps. (5 mm) · Inch version: 0 ~ 2.0" in 0.1" steps (0.2") <p>❷ Press the [OK] key.</p>

[Go to next page.]

SETTINGS YOU CAN CHANGE WITH THE USER TOOLS

- For details on accessing the user tools, ⇒ see page 56.
- Shaded items () are selected as the default setting.

Adjust Image 2/2

Description	Procedure
<p>5 D. Copy Sep. Line (Double Copies Separation Line)</p> <ul style="list-style-type: none"> · Changes the type of separation lines for double copies. ⇒ See page 38. <div style="display: flex; justify-content: space-around; align-items: flex-end;"> <div style="text-align: center;">  <p>None</p> </div> <div style="text-align: center;">  <p>Solid</p> </div> <div style="text-align: center;">  <p>Broken</p> </div> <div style="text-align: center;">  <p>Crop marks</p> </div> </div>	<ol style="list-style-type: none"> ❶ Select a type of separation lines with the  or  key. “None”, “Solid”, “Broken”, or “Crop marks” ❷ Press the [OK] key.
<p>6 Comb/IR Sep. Line (Combine/Image Repeat Separation Line)</p> <ul style="list-style-type: none"> · Changes the type of separation lines for Combine and Repeat modes ⇒ See pages 35 and 42. <div style="display: flex; justify-content: space-around; align-items: flex-end;"> <div style="text-align: center;">  <p>None</p> </div> <div style="text-align: center;">  <p>Solid</p> </div> <div style="text-align: center;">  <p>Broken 1</p> </div> <div style="text-align: center;">  <p>Broken 2</p> </div> <div style="text-align: center;">  <p>Crop marks</p> </div> </div>	<ol style="list-style-type: none"> ❶ Select a type of separation lines with the  or  key. “None”, “Solid”, “Broken 1”, “Broken 2”, or “Crop Marks” ❷ Press the [OK] key.

- For details on accessing the user tools, ⇒ see page 56.
- Shaded items () are selected as the default setting.

Input/Output 1/2

Description	Procedure
<p>1 Duplex Auto Eject</p> <ul style="list-style-type: none"> · As a default setting, when making two-sided copies from one-sided originals, the last copy paper can exit from the duplex tray automatically with the back side blank. You can change this setting. <input type="checkbox"/> This function is ineffective when you set one original at a time on the exposure glass or in the document feeder. 	<ol style="list-style-type: none"> ❶ Select “No” or “Yes” with the or key. ❷ Press the [OK] key.
<p>2 Comb. Auto Eject (Combine Auto Eject)</p> <ul style="list-style-type: none"> · As a default setting, even if the number of originals in the document feeder is less than the entered number in the Combine mode, copies can be made. You can change this setting. <input type="checkbox"/> This function is ineffective when you set one original at a time on the exposure glass or in the document feeder. 	<ol style="list-style-type: none"> ❶ Select “No” or “Yes” with the or key. ❷ Press the [OK] key.
<p>3 Original Count (optional document feeder required)</p> <ul style="list-style-type: none"> · Specifies whether or not to display the number of originals fed via the document feeder. <input type="checkbox"/> If you select “Yes”, the display shows the number of originals fed via the document feeder and copy count while copying. The entered copy sets are not displayed. 	<ol style="list-style-type: none"> ❶ Select “No” or “Yes” with the or key. ❷ Press the [OK] key.
<p>4 SADF Auto Reset (optional document feeder required)</p> <ul style="list-style-type: none"> · When you set one original at a time in the document feeder, the document feeder is ready for another (next) original after the selected time. You can adjust this time. ⇒ See page 5. 	<ol style="list-style-type: none"> ❶ Enter the time with the Number keys. <ul style="list-style-type: none"> · The entry value must be from 4 seconds to 60 seconds (in 1 second steps). · 4 seconds ❷ Press the [OK] key.









[Go to next page.]

SETTINGS YOU CAN CHANGE WITH THE USER TOOLS

SERVICE REPRESENTATIVE SETTINGS

- For details on accessing the user tools, ⇒ see page 56.
- Shaded items () are selected as the default setting.

Input/Output 2/2

Description	Procedure
5 Rotate Sort <ul style="list-style-type: none">· By default, the Rotate Sort is selected when you use sorting function. You can cancel this setting.	<ol style="list-style-type: none">❶ Select “No” or “Yes” with the  or  key.❷ Press the [OK] key.
6 R. Srt. Auto Pap. Cont (Rotate Sort Auto Paper Continue) <ul style="list-style-type: none">· In the Rotate Sort mode you can specify whether or not to continue copying onto available copy paper in the following cases:<ul style="list-style-type: none">· When  or  copy paper runs out during copying.· When copy paper identical in size but different in direction is not set in the paper tray.	<ol style="list-style-type: none">❶ Select “No” or “Yes” with the  or  key.❷ Press the [OK] key.
7 Sort Exit Priority (optional finisher is required) <ul style="list-style-type: none">· You can select the tray that copies exit to when using the sorting function with the optional finisher. If you select “Finisher”, the Sort mode is selected when using the sorting function. If you select “Output Trays”, the Rotate Sort or the Sort mode is selected. (⇒ See “5 Rotate Sort”.)	<ol style="list-style-type: none">❶ Select “Finisher” or “Output Trays” with the  or  key.❷ Press the [OK] key.

SERVICE REPRESENTATIVE SETTINGS

Some features can be adjusted by your service representative to suit your needs. This section gives a brief description of these features. For more information, contact your service representative.

A3, 11" x 17" Double Count



When you use A3, 11" x 17" paper, your service representative can set the machine to count each A3, 11" x 17" as two copies.

Auto Paper Select Small Size Detection (for metric version)

Your service representative can set the machine to detect the original size on the exposure glass as A5  whenever the machine cannot detect it with Auto Paper Select.

SPECIFICATIONS

MAINFRAME 66

Configuration:	Desktop
Photosensitivity type:	KZ-S OPC drum (ϕ 30)
Original scanning:	One-dimensional solid scanning system through CCD
Copy process:	Dry electrostatic transfer system
Development:	Dry two-component magnetic brush development system
Fusing:	Heating roll system
Resolution:	400 dpi
Grayscale:	256 levels
Exposure glass:	Stationary original exposure type
Original reference position:	Rear left corner
Memory capacity:	approximately 12MB
Warm-up time:	Within 40 seconds (20 °C)
Originals:	Sheet/book/objects
Maximum original size:	A3  , 297 x 420 mm, 11" x 17" 
Copy paper size:	See page 22 of the "General Reference" Duplex tray: See "SPECIFICATION : MAIN FRAME" in the "General Reference".
Copy paper weight:	
Paper tray:	60 - 90 g/m ² (16 - 24 lb)
Bypass tray:	60 - 157 g/m ² (16 - 41 lb)
Duplex tray:	60 - 90 g/m ² (16 - 24 lb)
Non-reproduction area:	Leading edge: 3 ± 2 mm Left edge: 2 ± 1.5 mm Trailing edge: 4 mm or less Right edge: 3 mm or less

First copy time: less than 9.8 seconds
 (A4 □, 8½" × 11" □ feeding from 1st paper tray and exiting to internal tray 1)
 less than 8.8 seconds
 (A4 □, 8½" × 11" □ feeding from 1st paper tray and exiting to external tray)

Copying speed: 13 copies/minute (A3 □, 11" × 17" □)
 25 copies/minute (A4 □, 8½" × 11" □)
 * in the Memory Copy mode

Reproduction ratio: Preset reproduction ratios ;

	Metric version	Inch version
Enlargement	400%	400%
	200%	200%
	141%	155%
	122%	129%
	115%	121%
Full Size	100%	100%
Reduction	93%	93%
	87%	85%
	82%	77%
	61%	65%
	50%	50%
	25%	25%

* When selecting the Text/Photo or Photo mode, or cancelling the Memory Copy mode, the minimum reproduction ratio is 50%.

Zoom: 25 - 400% (in 1% steps)
 Tolerance: 100% ± 1% (main scan, subscan)
 Enlarge/Reduce: ± 1% (main scan, subscan)

* When selecting the Text/Photo or Photo mode, or cancelling the Memory Copy mode, the minimum reproduction ratio is 50%.

Picture element density: 400 dpi

Continuous copying count: 1 - 99 copies

□ Specifications are subject to change without notice.

INDEX

Symbols

+Zoom Up key x, 27
-Zoom Down key x, 27
◀ ▶ xii
[↑Prev.] xii
[↓Next] xii
[Cancel] xii
[Clear] key 18
[Combine] key 36
[Copy] key 56
[Enlarge] 26
[Exit] xii
[Menu] xii
[OK] xii
[Output] key 18
[PrevMenu] xii
[Reduce] 26
[Series] key 34
1000-sheet tray unit (option) viii

A

A3, 11" x 17" Double Count 64
AC switch viii
Adjust Image 61, 62
AID Priority 59
APS Priority 59
ARDF ix
Auto Image Density 11
Auto Image Density key xi
Auto Paper Select 13
Auto Paper Select Small Size Detection 62
Auto Reduce/Enlarge 14
Auto Reduce/Enlarge key x, 15
auto reverse document feeder ix
Auto Start 24

B

BASIC PROCEDURE 10
BYPASS TRAY 19
Bypass tray viii

C

Clear Modes/Energy Saver key xi
Clear/Stop key xi
Comb. Auto Eject 63
Comb/IR Sep. Line 62
COMBINATION CHART 48
Combination of Auto and Manual
Image Density 12
Combine 35, 53
Combine/Series Copies key x, 34, 36
Copy Features 56
Copy Mode 57
Copy Paper 13

D

D. Copy Sep. Line 62
D. Size Mag. key 28
Direct. Mag.(%) key 30
Directional Magnification (%) key x
Directional Magnification(%) 29
Directional Size Magnification 28
Directional Size Magnification key x
Double Copies 38
Double Copies key x
Duplex 30, 54
Duplex Auto Eject 63
Duplex key x
Duplex Tray viii
Duplex Tray 51

E

EDITING 42
 Editing 42
 Editing key x, 43, 44
 Enter key xi
 Erase Border 61
 Erase Centre 61
 Erase Centre/Border 39
 Erase Centre/Border key x, 40
 Exposure glass viii
 External tray viii

F

Finisher ix
 Front cover viii
 Function key xi

G

General Features 60
 General Features 1/2 59

I

Input/Output 63, 64
 Internal tray 1 viii
 Internal tray 2 (option) viii
 Interrupt key xi, 23

L

Left Dup. Margin 61
 Left side cover viii
 Lighter and Darkey keys xi

M

MACHINE'S SETTINGS 55
 Main switch viii

Manual Image Density 12
 Manual Paper Select 14
 Max. Copy Q'ty 60
 Max. quantity 50
 Memory Copy key xi, 13
 messages 50

N

Number keys xi

O

OPERATION PANEL x
 Operation panel viii
 Options ix
 Orientn 32
 orig. size. 50
 Original Beeper 24, 60
 Original Count 63
 Original Priority 59
 Original Type 12
 Original Type key xi
 ORIGINALS 2
 Originals Of Special Sizes 7
 Overlay 44

P

Panel Display xii, xi
 paper size 50
 Paper tray viii
 Photo 13
 Photo Mode 60
 Platen cover viii
 Program 22
 Program key xi, 22

R

R. Srt. Auto Pap. Cont 64
Reduce/Enlarge 25
Repeat 42
Right Side Cover viii
Rotate Sort 16, 64

S

SADF Auto Reset 63
Series Copies 34
Setting Originals 4
Show All Keys 59
Sort 16
Sort Exit Priority 64
Sorter key x, 18
Special Size Copy Paper 20
Specifications 65
STAPLING 45
Start key xi

T

Text 13
Text/Photo 12
Top Dup. Margin 61
Top to Top/Top to Bottom 32

U

User Code mode 10
USER TOOLS 56
User Tools key x, 56
USER TOOLS MENU 58

V

Ventilation hole viii

Z

Zoom 27